



Thursday, April 13, 2023

To: Housing Developers, Community Agencies, Organizations, and Interested Parties

The Community Development Alliance (CDA) and the Local Initiatives Support Corporation (LISC) invite Housing Developers, Community Agencies, Organizations, and other interested parties to respond to this request for proposals (RFP) for the development and sale of approximately fifty (50) entry-level single-family homes (the "Project") in the City of Milwaukee (the "City") for homebuyers who are early childhood education professionals ("ECE Professionals") in connection with the Workforce Innovation Grant Program for the State of Wisconsin (the "Program").

**RFP# CDA 2023-001 – Early Childhood Education Homeownership Initiative – Fifty (50) New Construction Single-Family Homes for Immediate Homeownership**

CDA is issuing this RFP in collaboration with LISC, which has secured substantial grant funding through the Program to complete the Project, and the City which currently owns land to construct these new homes.

We welcome new prospective vendors, including joint ventures and other innovative partnerships, to participate in this RFP process (each a "Respondent" and collectively, the "Respondents"). Proposal materials will be available for download in electronic format beginning Thursday, April 13 from: [www.housingplan.org/rfp](http://www.housingplan.org/rfp)

One (1) informational session will be held virtually from Noon – 1:00 pm on Wednesday, April 19. [Click Here for registration.](#)

All proposals for funding in response to this RFP must be received by CDA no later than 4:00 p.m. on Monday, May 8, 2023. No extensions will be granted for submission of proposals.

Interviews of RFP Respondents will be conducted on Wednesday, May 17. Please hold this day open on your calendar. The evaluation team will invite the Respondents with the highest rankings to participate in an interview.

Proposals must be uploaded to: [www.housingplan.org/rfp](http://www.housingplan.org/rfp)

All proposals must be fully and completely uploaded to the above site by the deadline set forth above. Should an extension or modification of any deadline occur, there will be a notice via addendum posted at [www.housingplan.org/rfp](http://www.housingplan.org/rfp) to all Respondents. Such an extension will be available to all Respondents.

Thank you for your interest in this RFP.

Sincerely,

A handwritten signature in black ink, appearing to read "Teig Whaley-Smith".

Teig Whaley-Smith  
Chief Alliance Executive  
Community Development Alliance

A handwritten signature in black ink, appearing to read "Theodore Lipscomb, Sr.".

Theodore Lipscomb, Sr.  
Executive Director  
LISC Milwaukee

**RFP# CDA 2023-001 – Early Childhood Education Homeownership Initiative – Fifty (50) New Construction Single-Family Homes for Immediate Homeownership**

*Request for Proposals (Exhibits C & D Updated 4-26-23)*

**I. Background**

The Community Development Alliance (CDA) is a collaboration of housing funders, practitioners, and allies with the goal of advancing racial equity by providing a quality affordable home for every Milwaukeean.

LISC is a nonprofit organization, in existence for over forty (40) years, that serves as an intermediary to assist government, foundations, and for-profit companies in transferring much needed capital to local institutions, communities, and residents. LISC accomplishes these objectives by investing in businesses, housing, and community infrastructure to catalyze economic, health, safety, and educational mobility for individuals and communities.

In 2021, CDA worked with over 100 stakeholders to produce Milwaukee’s first [Collective Affordable Housing Plan](#) (the “Plan”). The Plan has been endorsed by the City, Milwaukee County, Greater Milwaukee Foundation, the Zilber Family Foundation, and many other crucial stakeholders.

Part of the Plan is to create new production models to produce more single-family and duplex inventory for homeowners. Further, to produce at least 100 new homes in the City for new homeowners to purchase each year. CDA and its allies have raised sufficient funds to meet this goal for 2022 and 2023, utilizing grant funding provided by the federal government pursuant to the American Rescue Plan Act of 2021 (“ARPA”) and the Program. During this once in a lifetime funding opportunity, CDA and its partners intend to (a) build as many homes as possible in the City for immediate homeownership and (b) identify long-term funding sources to supplement and eventually replace the funds provided through ARPA to increase the number of homes available for purchase in the City. This RFP will facilitate these efforts.

CDA, in collaboration with LISC, has raised a total of \$4.5 million to produce approximately 50 entry-level single-family homes that are available for immediate homeownership, targeting Early Childhood Education (“ECE”) professionals.

LISC has identified potential sites for entry-level single-family homes that are in proximity to five participating Early Childhood Education Centers (ECEs), further set forth in [Exhibit A](#) (Site Maps), which is attached and made a part of this RFP. Collectively, there are five maps, one for each ECE Neighborhood. The ECE Neighborhood Maps show all City-owned vacant lots around a given ECE Center. There are more vacant lots than are needed for the Project. There will be 10 new homes constructed around each ECE Center. The specific lots will be determined after the RFP. As part of your RFP response, you will be called upon to state how many homes that you have that capacity to develop in allotments of 10 homes. If you determine that your capacity is 10 homes, then you will select one ECE Neighborhood. Whereas, if you determine your capacity to be the development of 20 homes, then you will select two ECE Neighborhoods. You should rank each ECE Neighborhood from most preferred to least preferred. There is no guarantee that you will receive the number of ECE Neighborhoods that you request nor your preferred ECE Neighborhood(s).

CDA and LISC are working with the City to lay the groundwork for the Successful Respondents (as defined below) to complete the Project. For a fair comparison between the Respondents, CDA and LISC are requesting that each Respondent prepare a proposal based on the home design set forth in [Exhibit B](#) (Sample Unit Design), which is attached and made a part of this RFP. [Exhibit B](#) (Sample Unit Design) is a home design previously used by Milwaukee Habitat for Humanity International (Habitat); Habitat has permitted CDA and LISC to use the home design set for in [Exhibit B](#) (Sample Unit Design) for the Project. LISC will work with the Respondents selected to complete the Project, which shall include establishing a final design and budget for the Project.

CDA estimates that of the 37,500 Black and Latino families in the City who are eligible homeowners, approximately seventy percent (70%) of those families (or 26,000 Black and Latino families in the City) can afford a \$100,000 home. These 70% (or 26,000 Black and Latino Families) make between \$12 - \$24 hour/hour, and include ECE professionals, which is the target market of this Project. Attached is [Exhibit D](#) – Sample Sources and Uses, Detailed Budget and Homeownership

Affordability Analysis which results in a monthly permanent mortgage payment and overall housing cost affordable to ECE professionals which has been determined to be monthly Principal, Interest, Taxes, and Insurance of \$736 per month for an approximate \$87,000 permanent mortgage amount. Such estimates are further set forth in Exhibit D which is made part of this RFP.

## **II. Expectations of Successful Respondent**

CDA and LISC will select between two and five Successful Respondents. CDA and LISC will require the Successful Respondents to satisfy each of the following conditions to complete the Project:

- A. Agreement with LISC. Enter into an Agreement with LISC for up to \$4.5 million (the “Agreement”). The Agreement will require each of the Successful Respondents to comply with the requirements of ARPA, including 31 C.F.R. Part 35, Subpart A (Coronavirus State and Local Fiscal Recovery Funds) and 2 C.F.R. Part 200 (Uniform Guidance) (the “Uniform Guidance”).
- B. Land Sale and Cooperation Agreement with City. Enter into a Land Sale and Cooperation Agreement with the City and related agencies to facilitate the sale of the land identified by LISC for the Project (the “Project Land”). Staff from the City will prepare the necessary filings to facilitate the sale of the Project Land. The Successful Respondents will meet with local officials upon request and attend relevant public hearings held by the City in connection with the sale of the Project Land.
- C. Project Completion. Complete the Project by June 30, 2025. The Successful Respondents should develop the Project Homes in a manner consistent with Exhibit B (Sample Unit Design), and Exhibit C – Design Requirements which are attached and made a part of this RFP. The Successful Respondents must complete all stages of development required by LISC, including executing the construction agreements needed to complete the Project and facilitating the sale of the Project Homes to buyers meeting the requirements established by CDA and LISC (*e.g.*, certified ECE Professionals earning at or below one hundred percent (100%) of the median income of Milwaukee County or “AMI,” which amounts to \$24 per hour or \$50,000 per year). If any of the Project Homes remain unsold after a reasonable period of time (agreed upon by LISC and each of the Successful Respondents), then LISC and the Successful Respondents may make the unsold Project Homes available for sale to (i) another potential homebuyer meeting requirements established by CDA and LISC, (ii) the Milwaukee Community Land Trust, or (iii) Acts Housing, a local real estate brokerage that provides homebuyer and financing counseling, approved by the United States Department of Housing and Urban Development (“HUD”), to individuals looking to buy their first home, with a proven track record of assisting low-income households in achieving homeownership.
- D. Homebuyer Counseling and Mortgages. The Successful Respondents must work with each individual seeking to purchase one of the Project Homes to ensure each Qualified Buyer completes eight (8) hours of HUD-approved homebuyer counseling to (i) earn a homebuyer counseling certificate, (ii) qualify for permanent financing for the purchase of one of the Project Homes, and (iii) secure assistance for the down payment needed to purchase one of the Project Homes.
- E. Homeownership Deed Restriction. Include a permanent deed restriction in the loan documents and conveyance instruments for the Project Homes sold to ensure that the Project Homes are owned by homeowners and not investors. To accomplish this objective, the Successful Respondent must ensure a right of first refusal will be granted in favor of either the Milwaukee Community Land Trust or Acts Housing.
- F. Other Requirements. Other requirements deemed necessary by CDA and LISC to successfully complete the Project. This includes generally accepted financing and construction industry practices and processes such as fulfilling underwriting and grant requirements, gathering and evaluation of due diligence, legal documentation and contracts, satisfying funding disbursement criteria and project specific activities such as evaluating project sites, environmental conditions, budgets, financial modeling, use of Owner-Contractor contract, Subcontractor

contracts and Owner-Architect contract, that permits are in place, that architects, engineering and contractors have insurance and bonding, that a title company is utilized, that inspections are conducted and lien waivers collected.

### III. Support for the Successful Respondents

The Successful Respondents will receive the following assistance:

- A. Land Assistance. CDA and its allies have laid the groundwork to acquire the Project Land from the City. CDA will work with the Successful Respondents to meet with City staff, local officials, local neighborhood groups, and other relevant stakeholders to acquire the Project Land. City staff will prepare the files necessary to acquire the Project Land and CDA will provide public support for the submittal of such files.
- B. Financial Assistance. Successful Respondent will receive a portion of the \$4.5 million of financial support available, depending upon how many of the 50 units they will produce for the project, from LISC's allocation of Workforce Innovation Grant funds from the State of Wisconsin, which are Federal ARPA dollars. At least two and up to five Respondents will be selected.
- C. Other Assistance. CDA and LISC will provide additional support to the Successful Respondents as needed. For instance, LISC will work with the Successful Respondents to identify competitive construction financing needed for the Project. LISC is one potential provider of construction financing, however Successful Respondents can select a construction lender of their choice.

### IV. Submission Requirements

This RFP uses the equitable term "ability" to allow for submissions that include both past experiences and innovative approaches from those Respondents that have been excluded from past bidding opportunities. Proposals could include statements such as:

- "We have experience building single-family homes. For example, ... "
- "Although we have not yet built single-family homes, our approach would be . . ."

All submissions should be made electronically at [www.housingplan.org/RFP](http://www.housingplan.org/RFP). The response to each of the criterion listed below is limited to a paragraph (e.g. 1,000 characters or less).

- A. Price of the Project Homes. ARPA funds require an RFP that utilizes price as a component of evaluation. To do this, please provide the following detail: (1) the number of the Project Homes you can commit to build (either 10, 20 or 30 homes), (2) the amount of ARPA funds needed to produce each of the Project Homes, and (3) the total development cost per Project Home. A Sample Sources and Uses, Detailed Development Budget and Homeownership Affordability Analysis is provided. In addition, to a narrative answer, please upload a Sources and Uses Budget for a single home and for the total number of homes you are proposing.
- B. Ability to Build the Project Homes. Please advise us of your experience, or how you would approach, building the Project Homes (e.g. 1,000 square feet, 3 bedroom, 1 bathroom).
- C. Project Management Capacity. Describe your capacity to complete the Project. Include in your proposal the projects you are currently completing and how you will manage the Project and other commitments, as well as any assistance that you may need. Specify how many of the Project Homes you intend to construct in 2023, 2024, and the first six months of 2025.
- D. Ability to Serve the Milwaukee Neighborhoods for the Project. Please advise us of your experience, or how you would approach building relationships in the City neighborhoods further set forth in Exhibit A (Site Map), or similar neighborhoods. Please rank the ECE Neighborhoods from most preferred to least preferred.

- E. Ability to Advance Racial Equity Within Fair Housing Guidelines. Please advise us of your experience, or how you would approach, using the Project to reduce the racial homeownership gap and attract ECE Professionals, while remaining compliant with federal, state, and local fair housing laws.
- F. Ability to Serve Families Earning \$12- \$24/hour. Please let us know what experience you have, or how you would approach, serving families making \$12 - \$24/hour.
- G. Ability to Utilize Emerging Business Enterprises. Please let us know what experience you have, or how you would approach, the use of Emerging Business Enterprises (EBE) for development and construction, while being compliant with federal laws. Responses should include a goal of EBE or similar owned firm participation.
- H. Financial Capacity. Please advise us of your experience, or what will be your approach, to fulfilling your financial obligations for the Project. Your proposal response should address the developer equity, subsidy and construction financing requirements of the Project. The Sample Source and Uses Budget includes Developer Equity of \$5,000 per home. Please indicate if you could commit to contributing and raising these funds and what assistance you may need. You do not need to address the need for permanent financing as that is the obligation of the homebuyer.
- I. Developer Capacity. Share any training, certifications, licenses, and experience you have in developing and selling affordable, single-family homes. Include any development team members that you would utilize on this Project or those that you have worked with on past projects.

**V. Submission Scoring**

1.	Price of the Project Homes (i.e. # of single family homes to be completed, amount of subsidy needed to complete each home and total development cost per home)	10 Points
2.	Ability to Build the Project Homes	10 Points
3.	Project Management Capacity	10 Points
4.	Ability to Serve the Milwaukee Neighborhoods for the Project	10 Points
5.	Ability to Address Racial Equity Within Fair Housing Guidelines	10 Points
6.	Ability to serve families making \$12 - \$24/hour	10 Points
7.	Ability to Utilize Emerging Business Enterprises	10 Points
8.	Financial Capacity	10 Points
9.	Development Capacity	10 Points
	Total	90 Points

**VI. Timeline**

RFP Released	Thursday, April 13, 2023	
RFP Overview Meeting	Wednesday, April 19, 2023,	Noon. <a href="#">Registration Link.</a>
RFP Questions Due	Monday, April 24, 2023	
RFP Proposals Due	Monday, May 8, 2023	
RFP Interviews	Wednesday, May 17, 2023	
RFP Decision (est.)	Wednesday, May 24, 2023	
Submission of Land File	June 2023	
Land Public Meetings	July 2023	

Construction of Project Homes

August 2023 to June 2025

Sale to Homeowners

June 2025

## VII. Questions

Questions should be submitted by Monday, April 24 the RFP Questions due date to [ideas@housingplan.org](mailto:ideas@housingplan.org). All questions submitted by this deadline will be answered by Friday, April 28 and the answers will be posted at [www.housingplan.org/rfp](http://www.housingplan.org/rfp)

## VIII. Frequently Asked Questions

1. *How have other developers successfully completed projects to serve Black and Latino families while also complying with federal, state, and local fair housing laws?*

Families of color make up approximately eighty percent (80%) of the collective client base of our collaborating agencies and such agencies utilize policies that are consistent with federal, state, and local fair housing laws. This has been done through the use of race-neutral strategies such as providing services to (i) those individuals living in City zip codes where the median income is lower (as compared to other City zip codes), (ii) families earning lower incomes generally (as compared to other families living in the City), and (iii) first time homebuyers. Culturally aware networking, marketing, and outreach has also helped to reduce barriers to homeownership and wealth building that would otherwise exist without such efforts.

2. *Can a Respondent to other CDA RFPs?*

Yes

3. *What are the ARPA requirements?*

See Exhibit F (Terms Required for the Use of ARPA Funds)

4. *Do Davis-Bacon Act requirements (addressing prevailing wage rates) apply for the Project?*

Not if the only federal source of funds is from the ARPA. Davis-Bacon Act requirements will apply to the extent funds are obtained from any source or sources other than ARPA. See Coronavirus State and Local Fiscal Recovery Funds: Final Rule: FAQ (July 27, 2022), page 19, available at [SLFRF-Final-Rule-FAQ.pdf \(treasury.gov\)](https://www.treasury.gov/press-releases/2022/07/20220727).

5. *What happens if construction costs increase after the Successful Respondents respond to the RFP?*

Once the Successful Respondents identify the contractors that will work on the Project, CDA, LISC, the Successful Respondents, and other relevant stakeholders will revisit construction costs to determine the number of Project Homes feasible. Together, these parties will determine the next steps, whether raising additional funds or reducing the number of the Project Homes constructed.

6. *What property standards apply?*

The Successful Respondents must build the Project Homes in accordance with the standards set forth in Exhibit B (Sample Unit Design) and Exhibit C (Design Requirements). Once the Successful Respondents are selected, CDA, LISC, the Successful Respondents, and other relevant stakeholders will finalize design plans and initiate value engineering. The Successful Respondents and LISC will incorporate initial and amended design plans in the Development Agreement.

7. *Lowest responsible bidder vs. price consideration*

This RFP is not subject to the lowest responsible bidder standard, and rather the ARPA Uniform Guidance which requires price as a consideration, together with other considerations that are included in the RFPs scoring criteria.

8. *How many Respondents will CDA and LISC select under this RFP?*

The intention is to have no less than two (2) and no more than five (5) Successful Respondents, but CDA and LISC will make this determination based on the capacity and scoring of the Respondents.

9. *What community engagement has been done, and what is expected?*

This project has been designed to be consistent with the priorities of Community Development Alliance which identifies the construction of single-family homes for affordable sale as a high priority. There will need to be continuous resident collaboration and if there are significant changes needed in the project, the partners will work together to address.

10. *Can the project budget include a developer return, broker's fees, and other soft costs necessary to complete the project?*

The response requires the submittal of a per unit budget and a project budget (See Category A). Expenses such as developer return, broker's fees and other soft costs should be listed in these budgets. Respondents may include whatever costs they deem necessary as part of their internal calculations to successfully complete the project. Estimated project costs will likely be different for each Respondent. Once total project costs have been developed by Respondent, then there should be a determination of how many homes can be produced by the Respondent for the subsidy that is being requested. This number of homes and requested subsidy should be used to respond to Question A – Price of Project Homes.

11. *Are Successful Respondents permitted to construct duplexes as part of this Project?*

No.

12. *How should a Respondent utilize Emerging Business Enterprises if the Respondent does not currently track the use of Emerging Business Enterprises? What are enterprises that are similar to Emerging Business Enterprises? Who maintains a directory of these enterprises?*

The Respondent may include either its current experience with Emerging Business Enterprises, or the intended approach of the Respondent for this Project. Enterprises that are similar to Emerging Business Enterprises include:

- Small Business Enterprises (SBE) certified by the City of Milwaukee. See at [Small Business Development \(milwaukee.gov\)](http://Small Business Development (milwaukee.gov)).

- A Targeted Business Enterprise (TBE) certified by Milwaukee County. See [County of Milwaukee | DAS | Community Business Development Partners](#)
- A Disadvantaged Business Enterprise (DBE) certified by the state of Wisconsin through a Unified Certification Program. See [Wisconsin Department of Transportation Unified Certification Program \(UCP\) DBE certified firms \(wisconsin.gov\)](#)

*13. Are the Respondents required to submit a budget for the Project?*

Yes. The goal of the RFP is to evaluate the number of homes of the specified quality that can be produced for the \$4.5 million subsidy, or portion thereof (i.e. Question A – Price of Project Homes). CDA and its collaborators reserve the right to request additional project budget details for clarifying purposes in its evaluation of responses.

*14. Are the Respondents required to submit audited financial statements?*

No. Instead, each Respondent should provide a written response to question in Section IV. H. above (Submission Requirements; Financial Capacity) indicating whether audited financial statements have been prepared for the Respondent for any of the last three fiscal years, while also providing any significant findings contained in those audited financial statements. CDA and its collaborators reserve the right to request financial statements for evaluation purposes.

*15. Do all units have to be 3 bedrooms, 1 bath? Could we build 2, 3 and 4 bedroom models to offer a mix of choices to homebuyers of varying family sizes? Could square footage range from 800-1100 based on the design.*

It is important that the review of responses be “apples to apples” so for the purposes of the RFP all units should be the 3 bedroom, 1 bath, approximately 1,000 square foot units that are depicted in the RFP. Post award, successful respondent and CDA will review relevant market data to determine if any changes in number of bedrooms are warranted.

*16. Which party ultimately approves the designs for the Project Homes?*

The City and LISC will ultimately determine which designs the Successful Respondents will use to construct the Project Homes.

*17. What are the grant compliance / reporting requirements for the Successful Respondents?*

Each Successful Respondent must track the following and submit on a quarterly basis during the grant term:

- Total costs incurred for the Project
- Total costs allocated to funds provided through the Program / ARPA funds
- Number of Project Homes started and completed
- Demographics of homebuyers: family size, race, gender, income, employer, and zip code prior to purchase

*18. Which organization will oversee compliance and reporting for the Project?*

LISC will oversee the quarterly compliance and reporting. Each Successful Respondent is responsible for submitting data to LISC and otherwise complying with agreements entered into with LISC or the City.

**IX. Disclaimer**

CDA and LISC reserve the right to revise requirements of the Project to ensure all parties comply with the applicable federal, state, and local laws in place to accomplish purposes of the Project and the Program.



**X. Attachments**

**A. Submittal Requirements**

Template Submission Form

**B. Exhibits to Request for Proposals for Informational Purposes**

A - Site Maps

B – Sample Unit Design

C – Design Standards

D – Sample Sources and Uses, Detailed Budget and Homeownership Affordability Analysis

E – General RFP Requirements

F – Terms Required for the Use of Federal Funds

**EXHIBIT A – SITE MAPS**

**[SEE ATTACHED]**

## Exhibit A – Site Maps

### Neighborhood #1: Next Door Foundation Early Childhood Education

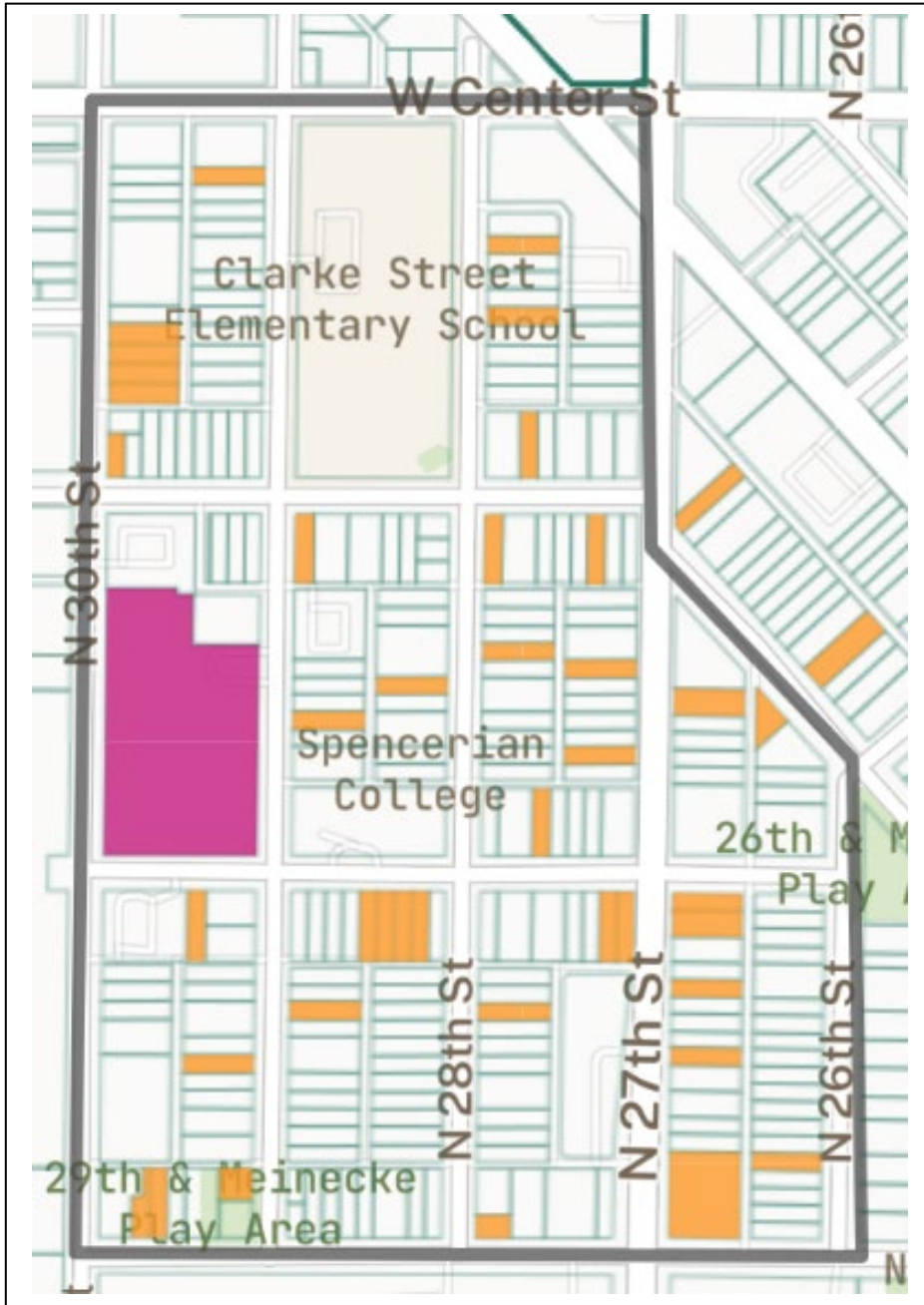



 **Next Door Foundation**  
Early Childhood Education  
at 2545 N. 29<sup>th</sup> Street.

 Vacant lot and potential project site.

# Exhibit A – Site Maps

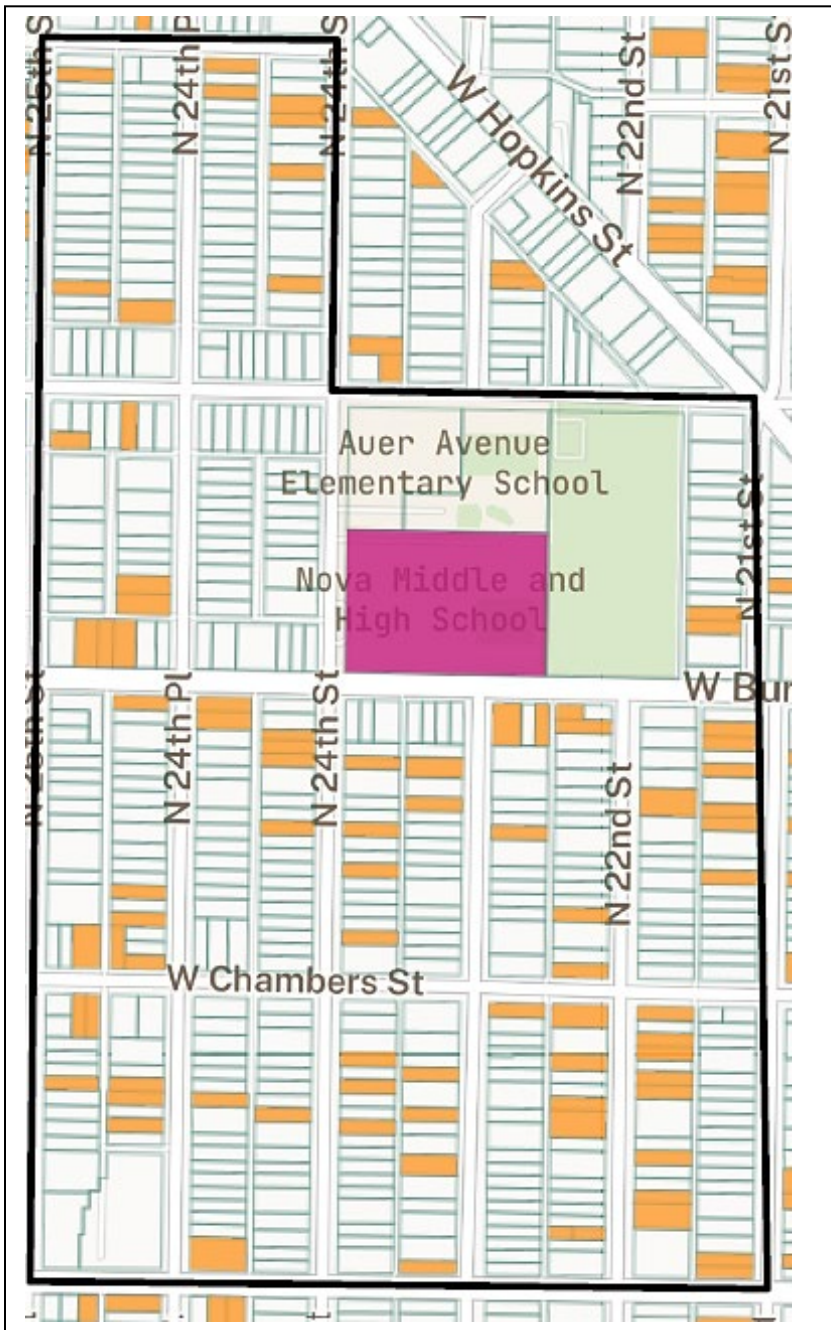
## Neighborhood #2: Children’s Outing Association Early Education Center





-  **Children’s Outing Association**  
Early Education Center  
at 2330 W. Burleigh Street.
-  Vacant lot and potential project site.

# Exhibit A – Site Maps

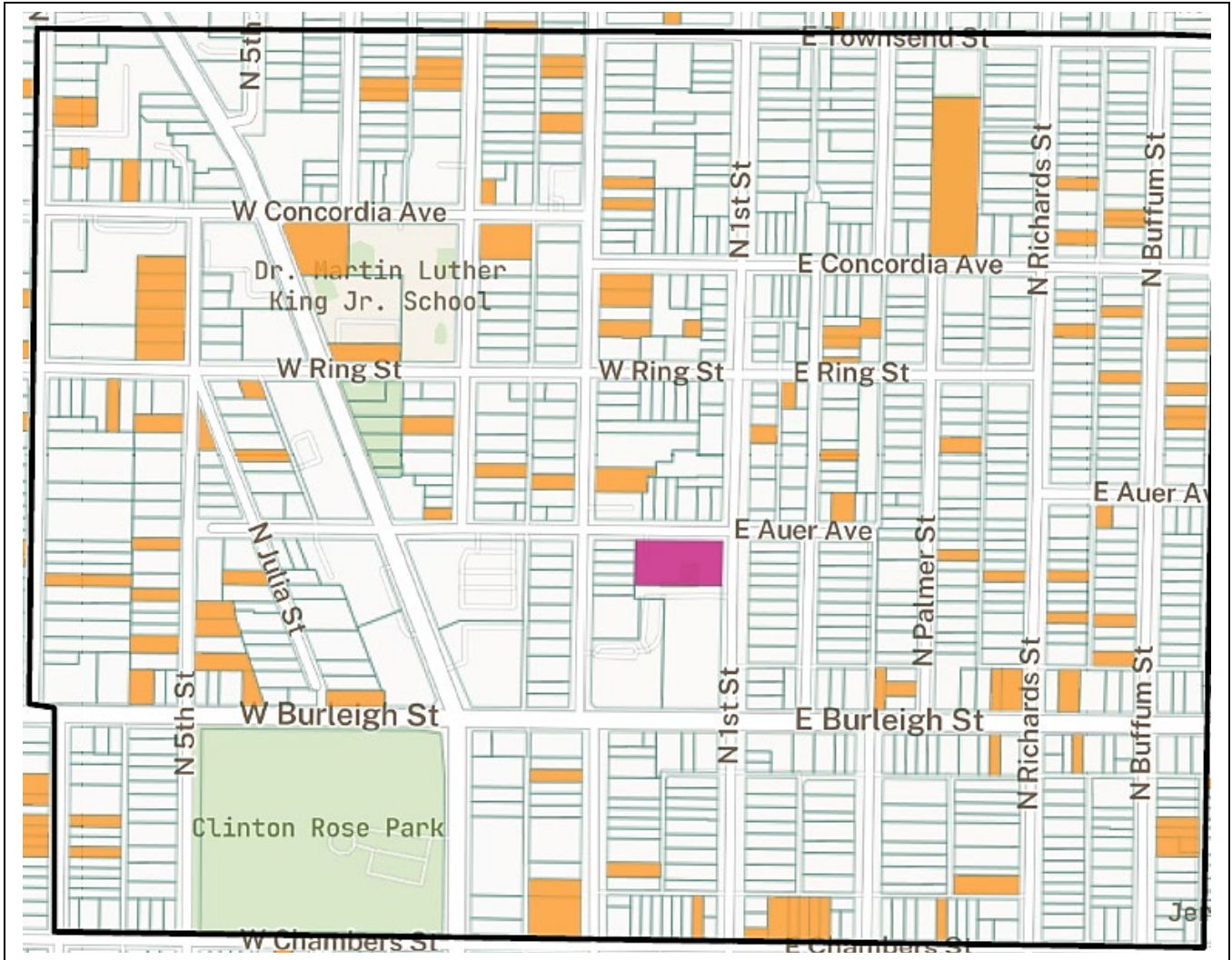
## Neighborhood #3: Maliaka Early Learning Center





 **Maliaka Early Learning Center**  
at 125 W. Auer Avenue.

 Vacant lot and potential project site.

# Exhibit A – Site Maps

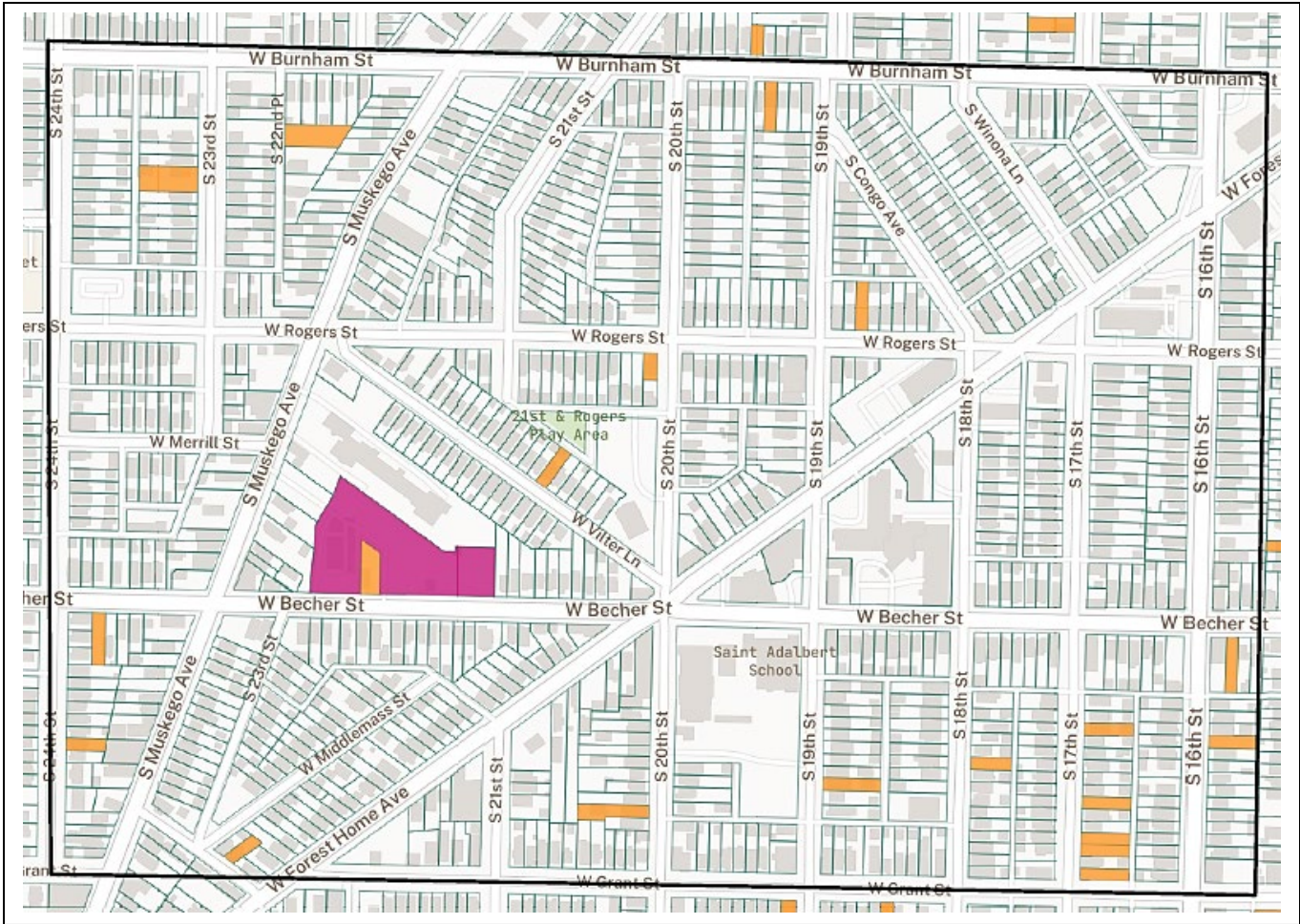
## Neighborhood #4: United Community Center Ricardo Diaz Early Learning Academy





-  **United Community Center**  
Ricardo Diaz Early Learning Academy at 2130 W. Becher Street
-  Vacant lot and potential project site.

# Exhibit A – Site Maps

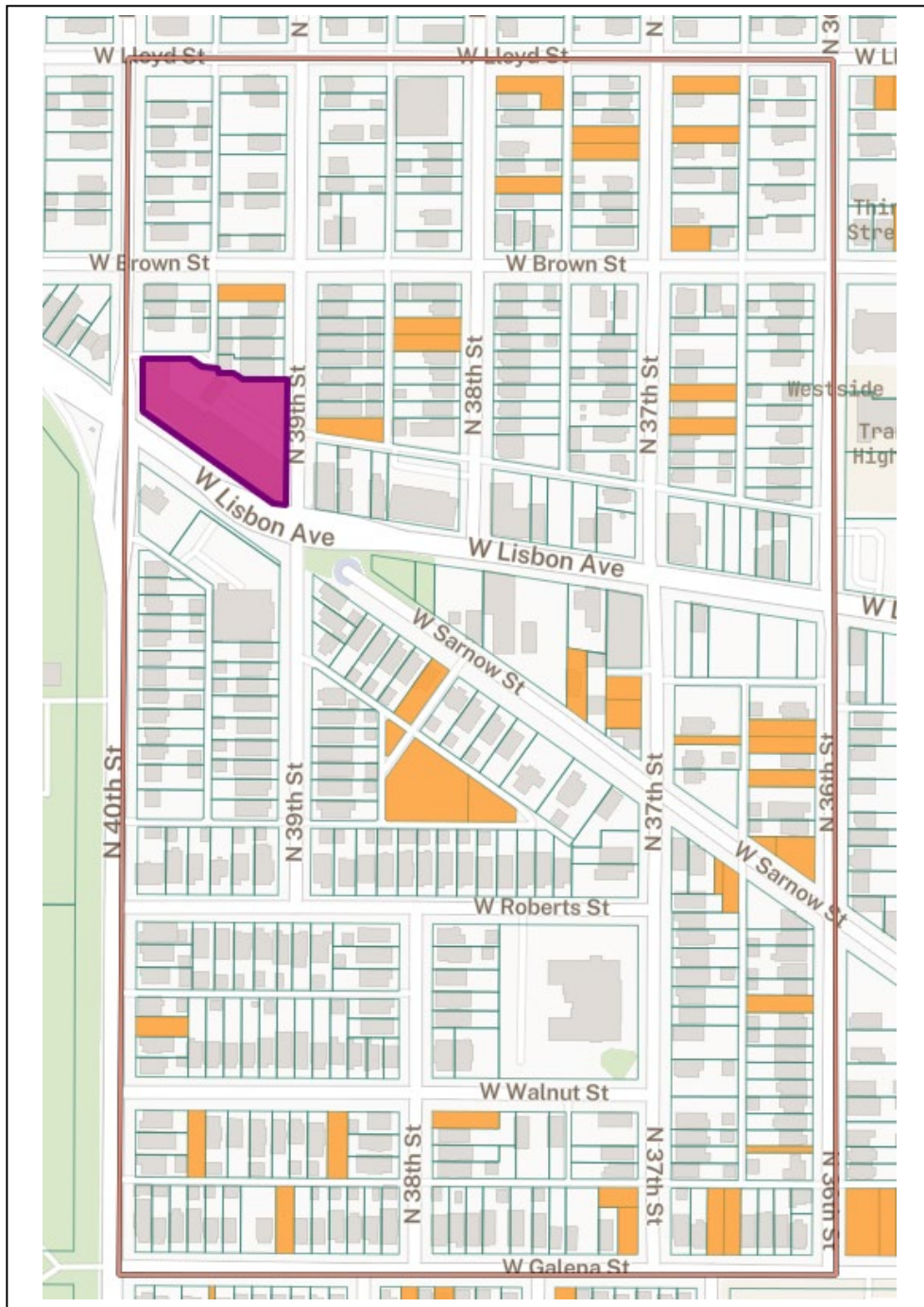
## Neighborhood #5: United Methodist Children’s Services Growing Tree Children’s Center



-  **United Methodist Children’s Services**  
Growing Tree Children’s Center  
at 3940 W. Lisbon Avenue
-  Vacant lot and potential project site.

**EXHIBIT B – Sample Unit Design**

**[SEE ATTACHED]**





# SINGLE STORY HOUSING

## PERMIT SET



**Quorum Architects, Inc.**  
 3112 West Highland Boulevard  
 Milwaukee, Wisconsin 53208  
 Phone: 414.265.9265  
 Fax: 414.265.9465  
 www.quorumarchitects.com

DATE: MARCH 15, 2023

PROJECT NUMBER: 11041-02

### GENERAL NOTES

- ALL INTERIOR PARTITIONS ARE DIMENSIONED TO FACE OF STUD UNLESS OTHERWISE NOTED.
- ALL EXTERIOR DIMENSIONS ARE FROM FACE OF SHEATHING (STUD+1/2"). EXTERIOR FACE OF SHEATHING AND FOUNDATION WALL ARE ALIGNED.
- ALL WALLS AND CEILINGS AT INTERIOR OF BATHS TO BE MOISTURE RESISTANT GYPSUM BOARD.
- ALL DIMENSIONS TO DOORS AND WINDOWS ARE TO CENTER OF OPENING.
- ALL EXTERIOR WALL FRAMING TO BE 2X6 WOOD STUDS.
- USE TEMPERED WINDOW AND DOOR GLAZING WHERE REQUIRED BY CODE.
- VERIFY ALL ROUGH OPENINGS FOR TUBS.
- ALL PRODUCTS AND MATERIALS TO BE INSTALLED PER MANUFACTURERS SPECIFICATIONS.
- COORDINATE AND PROVIDE BACKING FOR MILLWORK ATTACHED OR MOUNTED TO WALLS OR CEILINGS.
- ALL WORK SHALL COMPLY WITH APPLICABLE LOCAL, STATE, AND FEDERAL CODES, LAWS, ORDINANCES, RULES, AND REGULATIONS OF PUBLIC AUTHORITIES GOVERNING THE WORK.
- ALL CONTRACTORS SHALL SECURE AND PAY FOR ALL REQUIRED APPROVALS, PERMITS, FEES, AND LICENSES AS IT APPLIES TO HIS/HER DISCIPLINE PRIOR TO EXECUTION OF WORK.
- ALL WORK IS TO BE COMPLETED USING ACCEPTABLE CONSTRUCTION PRACTICES AND QUALITY MATERIALS.

### STAIR NOTES

- TREADS ARE 10" MEASURED NOSING TO NOSING.
- RISERS ARE TO BE EQUAL IN HEIGHT BETWEEN EACH FLIGHT. MAXIMUM RISER HEIGHT TO BE 8".
- HANDRAILS TO BE MOUNTED AT 34" TO TOP OF RAIL.

### BUILDING CODE ANALYSIS

NEW SINGLE-FAMILY DWELLING PER THE UNIFORM DWELLING CODE (UDC), CHS. SPS 320-325 OF THE WISCONSIN ADMINISTRATIVE CODE (LATEST EDITION) AND ITS ADOPTED REFERENCES AND REVISIONS.

STORIES: ONE STORY WITH UNFINISHED BASEMENT  
 BASEMENT = 1008 SF GROSS  
 FIRST FLOOR = 1022 SF GROSS

### WINDOW TYPES

WINDOWS TO BE VINYL SINGLE-HUNG OR FIXED WITH INSULATED GLAZING. FENESTRATION TO MEET ENERGY CONSERVATION REQUIREMENTS OF WISCONSIN SPS 322.76 AND 322.37 (AIR LEAKAGE). ALL WINDOWS TO BE CLEAR DOUBLE-GLAZED INSULATED UNITS. MINIMUM WINDOW ASSEMBLY U-FACTOR IS U-0.64 FOR OPERABLE UNITS AND U-0.63 FOR FIXED UNITS.

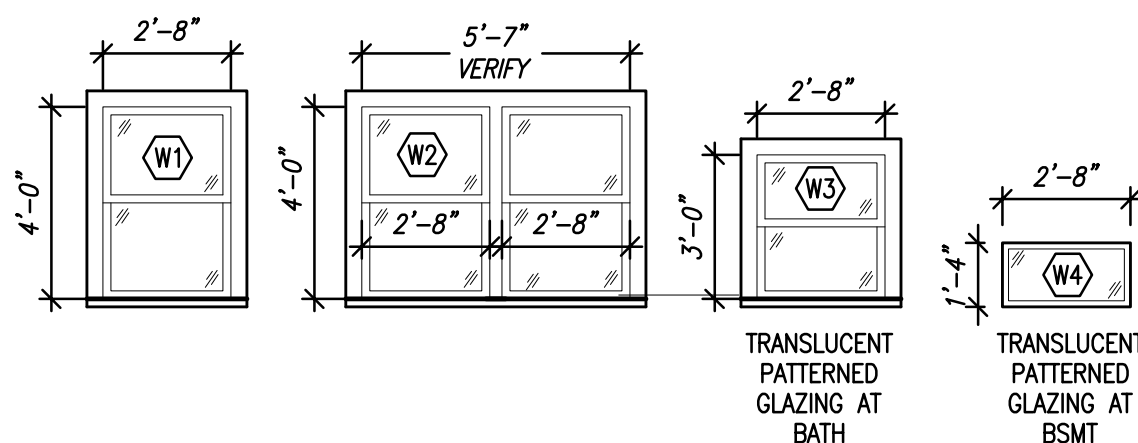

### PLAN NOTES

- EXTERIOR WALLS SHALL BE 2X6 STUDS AT 24" O.C. UNLESS NOTED OTHERWISE.
- INTERIOR WALLS SHALL BE 2X4 STUDS AT 24" O.C. UNLESS NOTED OTHERWISE.
- WINDOW, DOOR AND OPENING HEADERS IN EXTERIOR WALLS SHALL BE (2)-2X10'S WITH A 2-1/2" FOAM SPACER.
- INTERIOR NON-LOAD BEARING HEADERS SHALL BE (1)-4X4.
- POSTS SUPPORTING BEAMS SHALL BE (2)-2X4, GLUED AND NAILED, MINIMUM UNLESS NOTED OTHERWISE. MINIMUM POST WIDTH TO MATCH BEAM WIDTH. POSTS SHALL BE BLOCKED TO BEAM OR FOUNDATION BELOW.

### CONTACT INFORMATION:

#### ARCHITECTURAL

QUORUM ARCHITECTS, INC.  
 3112 West Highland Boulevard  
 Milwaukee, WI 53208  
 Phone: (414) 265-9265  
 Fax: (414) 265-9465  
 Contact: Emily Neal  
 Email: EmilyN@quorumarchitects.com

### DRAWING INDEX:

CS COVER SHEET, GENERAL NOTES AND WINDOW SCHEDULE

#### ARCHITECTURAL

- A1.0 FLOOR PLANS
- A3.0 EXTERIOR ELEVATIONS
- A3.1 EXTERIOR ELEVATIONS
- A4.0 TYPICAL WALL SECTION

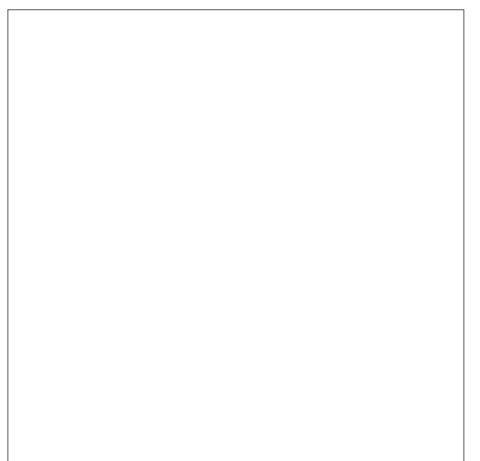
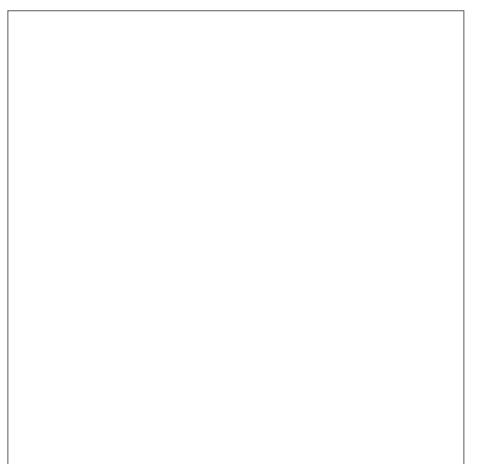

HABITAT FOR HUMANITY  
 SINGLE STORY

PERMIT SET





**Quorum Architects, Inc.**  
 3112 West Highland Boulevard  
 Milwaukee, Wisconsin 53208  
 Phone: 414.265.9265  
 Fax: 414.265.9465  
 www.quorumarchitects.com



**MILWAUKEE HABITAT  
 FOR HUMANITY  
 SINGLE STORY**

Revisions:

Sheet Name:  
 EXTERIOR ELEVATIONS

Date: 03/15/2023

Drawn By: EN

Project No.: 11041-02

Sheet No.

**A3.0**

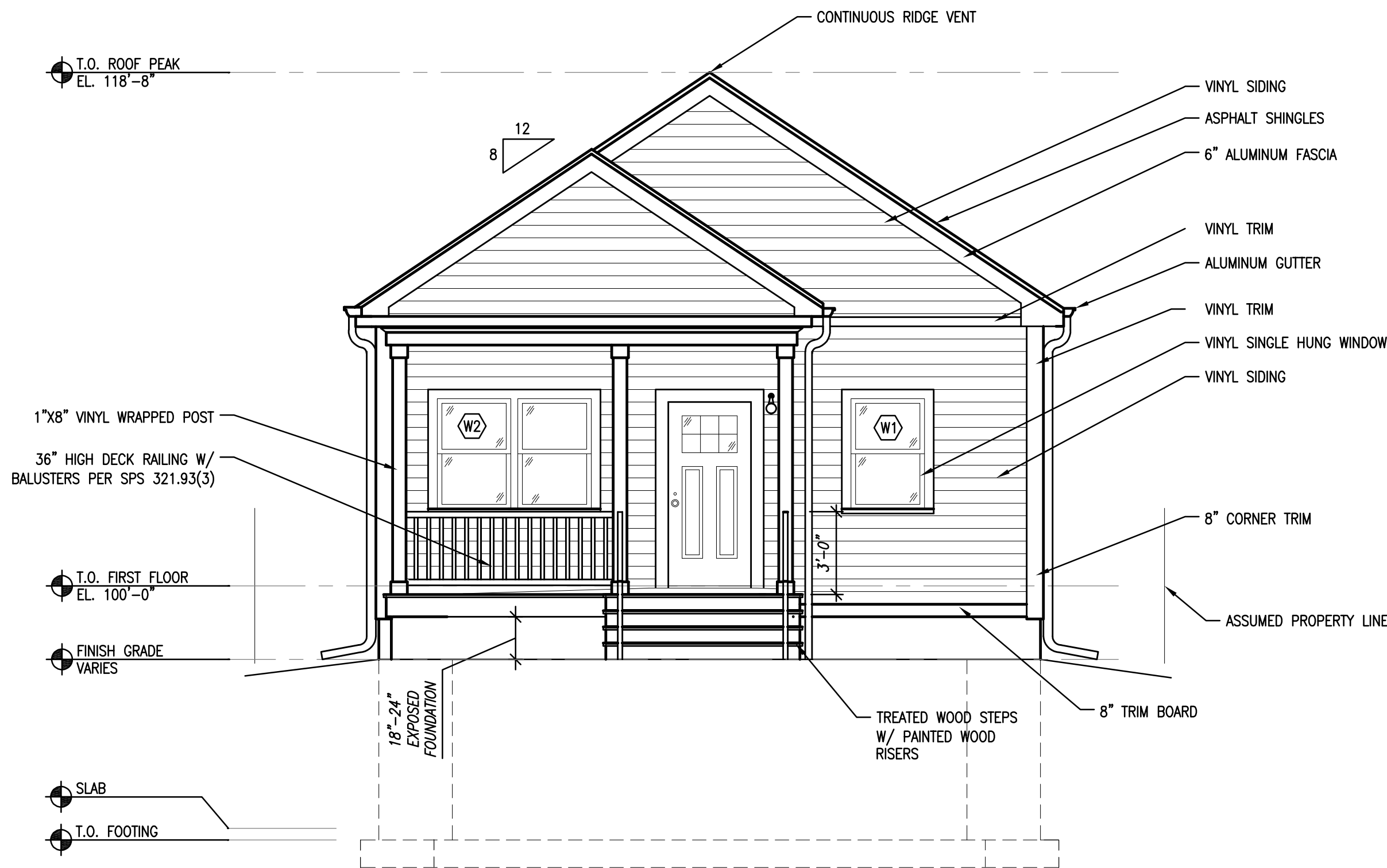

**1 FRONT ELEVATION**  
 SCALE: 1/4" = 1'-0"

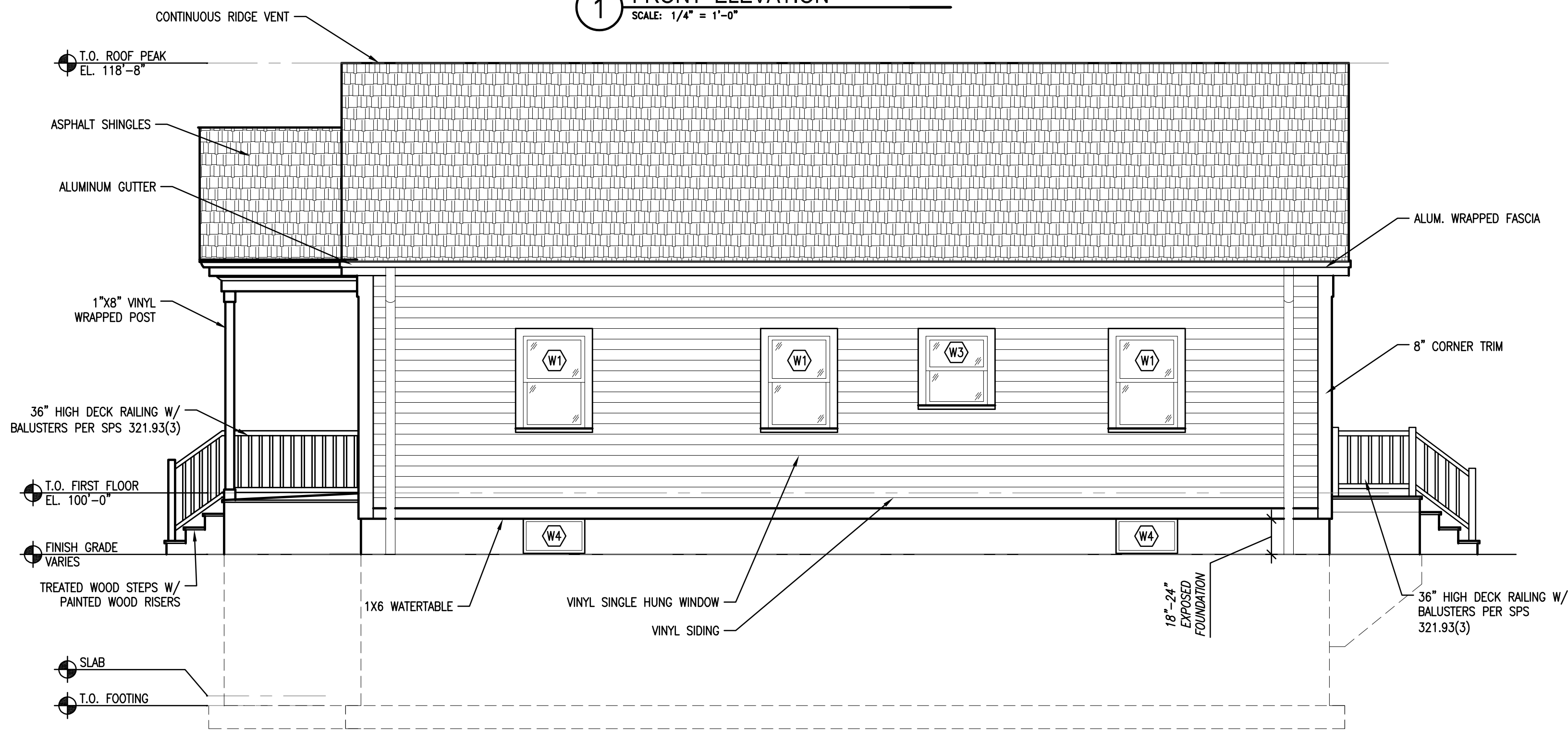

**2 SIDE ELEVATION**  
 SCALE: 1/4" = 1'-0"



**Quorum Architects, Inc.**  
 3112 West Highland Boulevard  
 Milwaukee, Wisconsin 53208  
 Phone: 414.265.9265  
 Fax: 414.265.9465  
 www.quorumarchitects.com



**MILWAUKEE HABITAT  
 FOR HUMANITY  
 SINGLE STORY**

Revisions:

Sheet Name:  
 EXTERIOR ELEVATIONS

Date: 03/15/2023

Drawn By: EN

Project No.: 11041-02

Sheet No.

**A3.1**

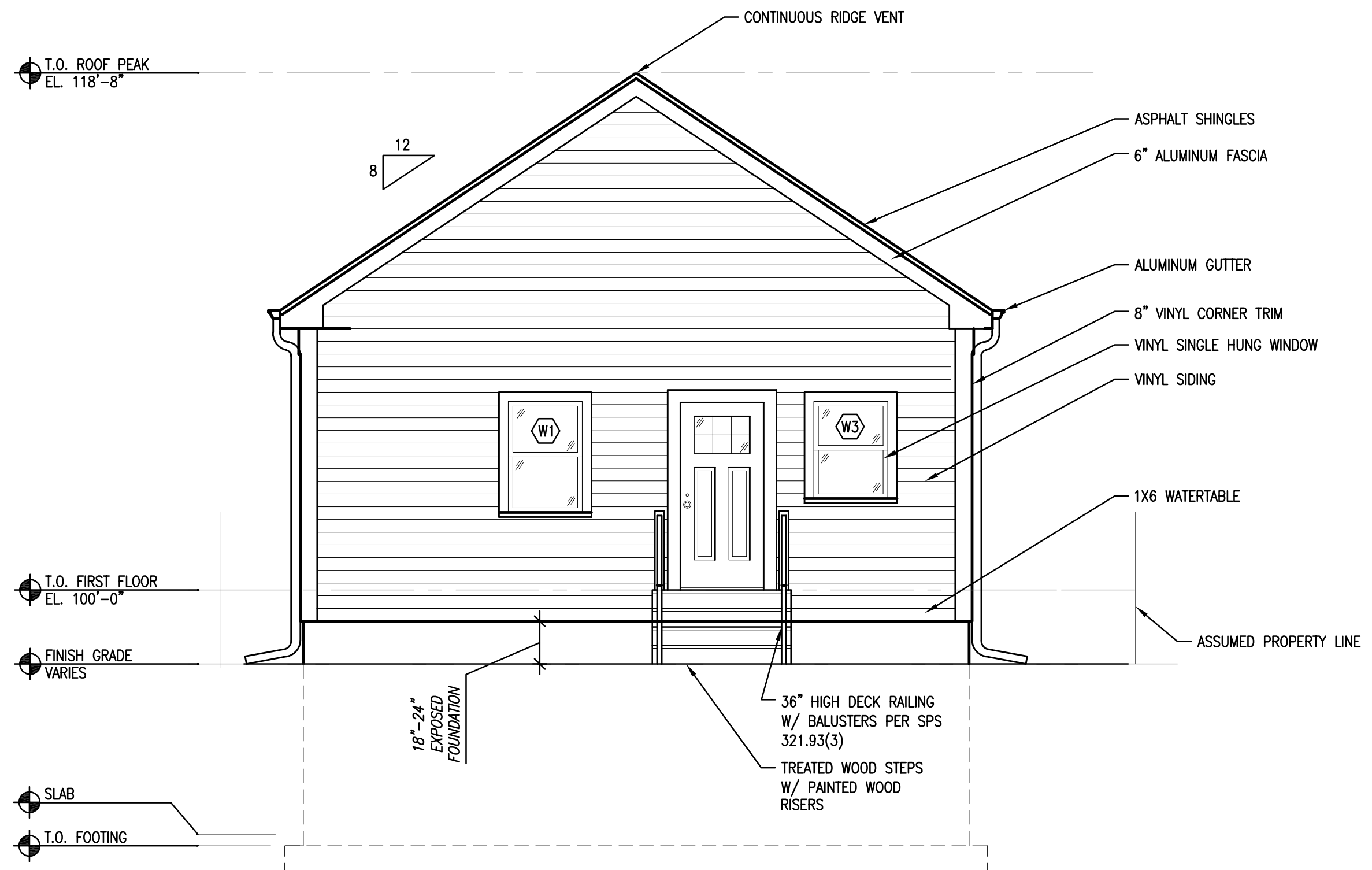

**1 REAR ELEVATION**  
 SCALE: 1/4" = 1'-0"

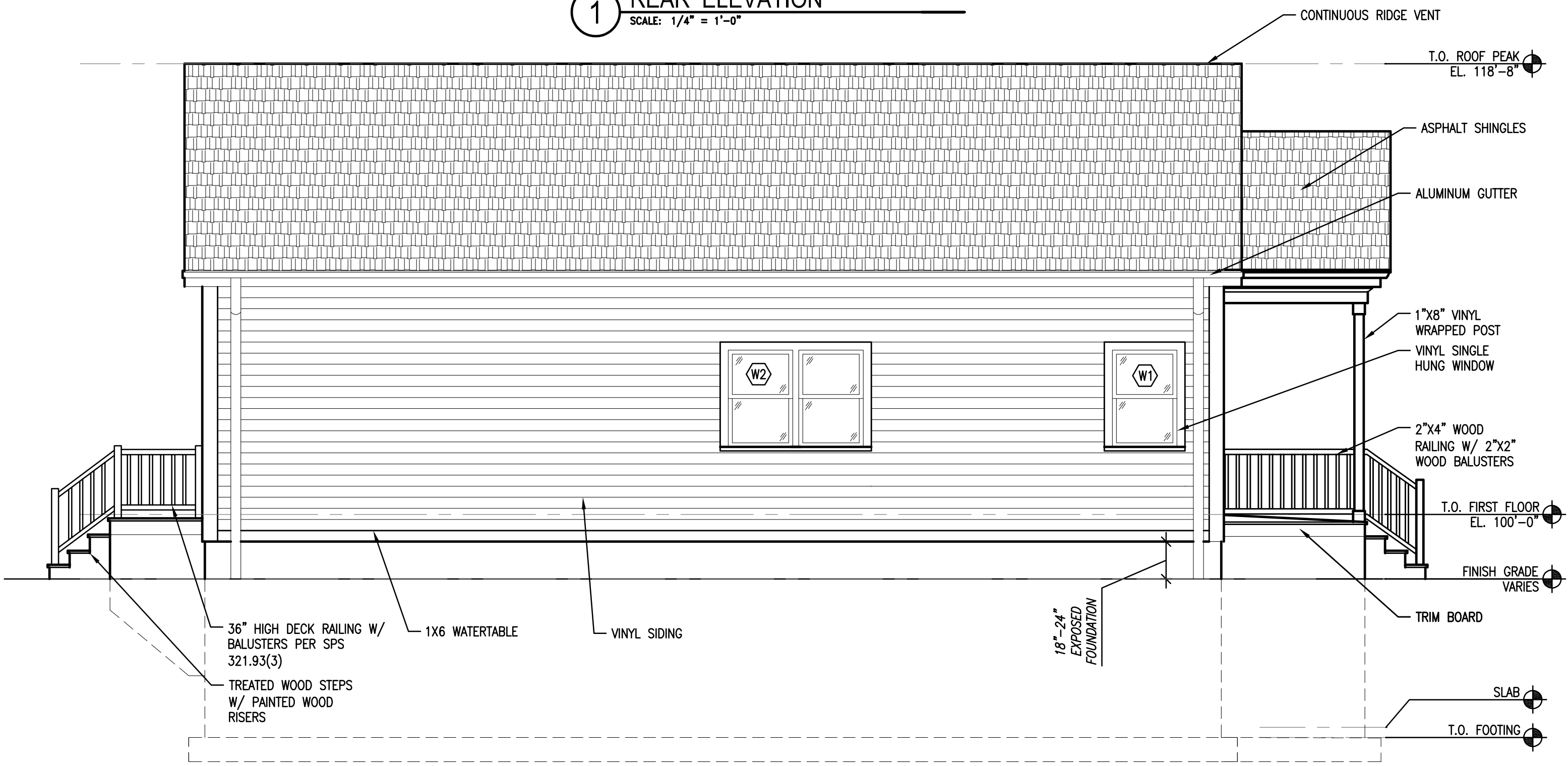

**2 SIDE ELEVATION**  
 SCALE: 1/4" = 1'-0"

Mar 15, 2023 - 10:30am  
 O:\11 Projects\11041-00 Habitat for Humanity\11041-02\_MKE Flats\CDS\11041-02-A3-0\_A3-3\_18X24.dwg  
 © Copyright 2023, Quorum Architects, Inc.



**Quorum Architects, Inc.**  
 3112 West Highland Boulevard  
 Milwaukee, Wisconsin 53208  
 Phone: 414.265.9265  
 Fax: 414.265.9465  
 www.quorumarchitects.com



**MILWAUKEE HABITAT  
 FOR HUMANITY  
 SINGLE STORY**

Revisions:

Sheet Name:  
 TYPICAL  
 WALL SECTION

Date: 03/15/2023

Drawn By: EN

Project No.: 11041-02

Sheet No.

**A4.0**

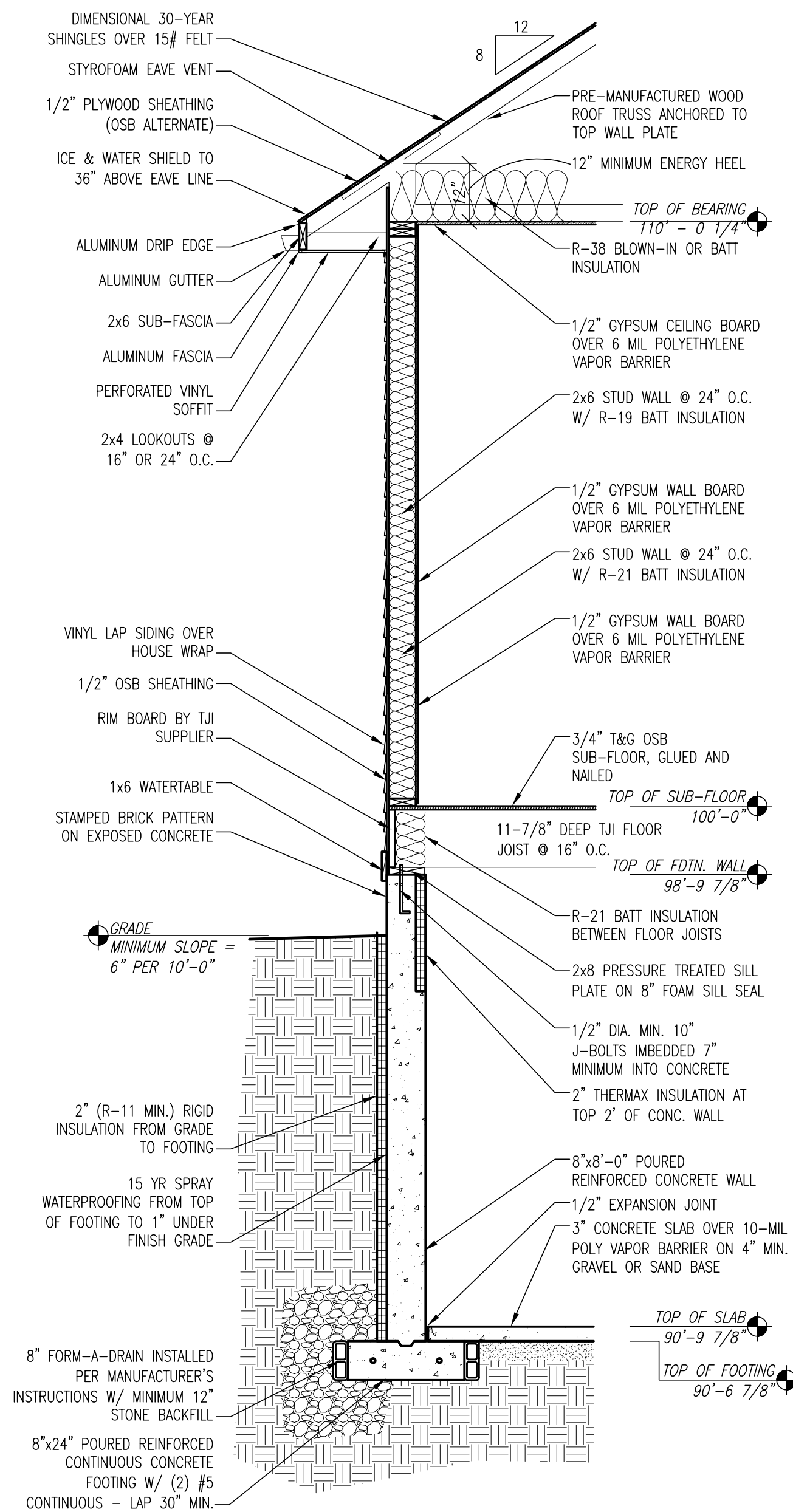

**1 TYPICAL WALL SECTION**  
 SCALE: 1/2" = 1'-0"

## EXHIBIT C – Design Requirements

Homes will be constructed to the following minimum standards:

### Type of Construction

- Full basement (8' deep)-nominal.\*
- Wood frame (2x6 exterior / 2x4 interior framing) 24" on center.
- Roof pitch to be 8/12 with gable ends, or as otherwise indicated on plans.
- Shingles on roofs to be 30 year dimensional over 15# felt over Ice and Water (3' coverage at gutter lines and valleys).
- Ridge vents to be installed along the entire roof line. Soffit vents to be continuous under the eaves.
- Gutters and downspouts to be aluminum with minimum 3' plastic extensions.
- Exterior wall surfaces and soffits to be vinyl. Fascia coverings to be aluminum. Wall vinyl to be double 4" lap.
- Soffit on porch ceiling to be solid, soffit on eaves to be vented.
- ~~As an alternative to a Full Basement, additional above grade space that can accommodate typical basement uses such as space for heating, water and electrical systems as well as laundry, household storage and family recreation space or an extra bedroom.~~

### Insulation

- Minimum of R-19 blown-in cellulose or fiberglass batt insulation in exterior walls.
- R-50 blown-in cellulose insulation in ceilings.
- R-21 expanding foam around 1<sup>st</sup> floor rim joists.
- R-5 expanding foam at all attic penetrations.
- R-10 (2" Dow) rigid foam on the exterior foundation walls from footing to grade.
- R-13 (2" Thermax) rigid foam on interior foundation walls from grade to top of wall.
- For basements poured before winter (meant for a spring framing start), R-10 (2" Dow) rigid foam under the entire sub grade cement slab

### Doors / Interior Trim

- Two 3'-0" x 6'-8" steel clad entry doors with peepholes
- Grade 2 deadbolt and entry lock on front and rear doors keyed alike.
- All interior door hardware to be satin nickel lever style.
- Prefinished pre-hung hollow core wood interior doors.
- All interior doors to living space on the primary floor will be 3'-0" wide.
- Closets with a width of 4'-0" or greater will have sliding doors, width of 3'-0" and less will be swinging.
- Storm doors or security doors are not included.
- Interior trim to be white (base, shoe, casing, & door slabs)

### Windows

- Single hung vinyl with integral exterior J-channel for vinyl siding.
- All glass to be Low-E, double-glazed, argon-filled. No grills.
- R-Value/U-Factor shall meet ENERGY STAR standards.
- Includes half screens.
- Safety glazing as required per code.
- Returns around window opening to be drywall (top, bottom, and sides)

### Heating, Ventilation and Air Conditioning

- Ducted, central forced-air heating system
- Natural gas, 95.5% AFUE, single stage 60 kBTU furnace and programmable thermostat.
- Note: May be manufactured 1-3 years before installation date. Not previously used.
- 14 SEER 2.0 Ton A/C unit.  
Note: May be manufactured 1-3 years before installation date. Not previously used.
- Ceiling fans with lights in the living room and all bedrooms.
- Rangehood over the stove ducted to the exterior.
- Bath fans are ducted to the exterior.

- First floor bath fans to be Broan AE110SL or similar.
- Dehumidifier to be provided with relative humidity control, direct drain to a floor drain.

### **Basement**

- Natural gas 40-gallon, power-vented water heater.
- Note: May be manufactured 1-3 years before installation date. Not previously used.
- Water heater with the manufacturer's warranty.
- Sealed sump pump pit that discharges to grade.
- Passive radon vent from sump crock to roof.  
Note: If a homeowner pays for a 3rd party radon test before closing and the results come back with unsafe levels of radon (4 pCi/L per the EPA), installation of a radon vent fan.
- Junction box for potential future radon fan installed regardless of radon test results.
- An area to be provided for the installation of a clothes washer and dryer.
- Water supply, electrical outlet, and drain plumbing shall be provided for the washer.
- Gas supply, 220V outlet, and horizontal dryer vent hood shall be provided for a dryer.
- Homeowner responsible for ducting from dryer to vent hood.
- Laundry tub – 18 Gallon freestanding.
- Washer and dryer are not included.
- One way backwater prevention valve in sewer line under basement floor.
- One frost-protected hose bib to be provided on the home exterior through basement rim joist.
- 3" poured concrete floor slab. 2" foam may be installed under slab depending on when the foundation was poured.
- Exterior of foundation to be covered in waterproof membrane below grade.
- Drain tile around the entire footing to drain to sump crock.

### **Kitchen**

- Refrigerator/Freezer and Range to be provided.
- Refrigerator/Freezer to be over/under style, 30" wide, 18 cubic foot, ENERGY STAR compliant.
- Range to be 30" wide. Prepared for natural gas and electric.
- Counter tops to be plastic laminate.
- Kitchen sink to be double basin, stainless steel sink 33" x 22".
- Dishwasher to be 24" wide, ENERGY STAR compliant .
- A switched outlet to be provided under the kitchen sink for a future homeowner provided garbage disposal.

### **Bathroom**

- Three bedroom houses to have one full bathroom
- Main bathroom area to include a multi piece fiberglass tub/shower unit.
- Bathrooms to include a 24" vanity cabinet, with a one-piece cultured-marble vanity top, a lavatory, and a wall mirror. Wall fixtures to be provided include a towel bar, toilet paper holder and shower curtain rod.
- Drywall in the bathroom to be moisture resistant.

### **Interior Surfaces**

- Walls and ceilings to be orange peel finish. All interior rooms walls and ceilings to be finished in an off-white paint color.

### **Window Coverings**

- Mini blinds to be installed on all windows.

### **Flooring**

- Vinyl plank floor (wood-look) to be provided throughout the kitchen, living room, first floor common areas, first floor bathroom, and bedrooms.
- Basement stairs to be painted with floor enamel.

### **Vehicle Parking, and Walkway**

- A 20' x 20', 2-car parking pad with alley access and 4' approach to be provided.
- o If no alley access available on lot, a 10' wide concrete driveway to the parking pad will be provided.

- A 4' wide concrete walkway to be provided to each entrance.

### **Entrance**

- All homes to include a covered front entrance.
- Front porch to be constructed out of pressure treated lumber including deck, railings, and roof supports.
- Uncovered stoops to be provided at all rear/side entrances.
- Stair railings to be provided where required by Wisconsin Building Code.

### **Fences**

- Rear yard to be fenced with 48" high chain link fencing from the rear of the house to the top of the parking pad.
- Fence to connect to neighboring fences when they are deemed sufficient.
- See separate drawing for standard fence layout on varying lot types.

### **Electrical Supply, Lighting, Security, and Wiring**

- An electrical panel with a 100-ampere capacity to be provided.
- Wiring to be provided for one cable outlet and one cat5 outlet in the living room.
- All homes to be equipped with 120V hard-wired smoke detectors and carbon monoxide detectors per code.
- A doorbell chime to be provided with doorbell buttons at each exterior door.
- Two outdoor GFCI electrical outlets to be installed.
- Energy saving light bulbs will be used where possible.
- Exterior motion flood light to be mounted to the rear of the house.
- Basic monitored security system to be provided with motion, audio, and door sensors.

### **Closets**

- One shelf and clothes rod to be provided in each closet.
- Pantry and linen closets to have 4 shelves.

### **Attic**

- An attic access hatch as required per code. Attics are not intended or designed to provide storage. Attic area to be filled with blown insulation. Attic access panel to be insulated and sealed.

### **Landscaping**

- 4 shrubs to be planted in front of home.
- Front yard to add seeding with erosion netting, side and rear yard to be seeded.
- Existing trees will not be removed unless they are deemed unhealthy, or are directly in the way of construction (within 20' of the house, within the footprint of any flatwork or along the property line).

### **Accessibility Standards**

CDA and LISC value the dignity and contribution of people with disabilities. Having a disability is a status that anyone one of us can have at any time, and we all will experience with age. Consequently, homes built will include measures to make sure that homes are adaptable overtime for visitability by those with a disability, and includes at least the following:

1. **Doors and Hallways.** All doors will have an opening of 32 inches or more (measured from open door face and opposite frame) (e.g. 36" door). All hallways will have a width of 36 inches or more. Navigation through kitchen will have a width of 40 inches or more.
2. **Plan for Zero Grade Entry.** We understand that with the unique size and grading of City of Milwaukee vacant lots, that net zero entries typically require ramps. Consequently, each home should have a plan on how a ramp can be added by the homeowner when desirable. Often this will mean utilizing the rear of the home which is farther from setbacks, and typically flatter. Every effort should be made to minimize the number of steps into homes to reduce the steepness of future ramps, and ensuring sufficient clearance inside the door for turning in a wheelchair.
3. **Bathrooms.** Bathrooms should be built at least to the standard of [Fair Housing Act Type B Bathroom Units](#) which include reinforced wall area for future grab bars near toilet and shower, bath tub/shower and toilet on opposite sides, and a 30" by 48" minimum clear floor space outside swing of door. Plumbing should be located to allow for reasonable replacement with accessible features in the future (e.g. roll in shower, lever faucets, etc.).



**EXHIBIT D – SAMPLE SOURCES and USES, DETAILED BUDGET and HOMEOWNERSHIP AFFORDABILITY ANALYSIS**

**[SEE ATTACHED]**

## SAMPLE: Sources & Uses

### Construction Financing Sources

ASSUMPTIONS	
Hard Cost / Square Foot	\$ 173.13
Square Feet	1000
Soft Costs	9.7%
Developer Fee	10.0%
General Contractor Fee	10.0%
Hard Cost Contingency	5.0%

CALCULATIONS	
Developer Fee	\$ 17,040.00
General Contractor Fee	\$ 14,990.00

SOURCES	
State of Wisconsin ARPA Subsidy	\$ 109,000.00
Construction Loan Financing	\$ 79,634.50
Developer Equity	\$ 5,000.00
Deferred Developer Fee (earned upon home sale)	\$ 17,040.00
Total	\$ 210,674.50

USES	
Hard Costs	\$ 149,900.00
General Contractor Fees	\$ 14,990.00
Hard Cost Contingency	\$ 8,244.50
Soft Costs	\$ 20,500.00
Developer Fee	\$ 17,040.00
Total	\$ 210,674.50

### Permanent (Takeout)/ Buyer Financing

Homebuyer Mortgage	\$ 86,674.50
Buyer's Equity - Downpayment Assistance	\$ 15,000.00
State of Wisconsin ARPA Subsidy	\$ 109,000.00
Total	\$ 210,674.50

## SAMPLE: Detailed Budget

### Detailed Budget

Type	Description	Cost
<b>HARD COSTS</b>		
1 Construction	Site work & Utilites	\$ 1,500
2 Construction	Demolition	\$ -
3 Construction	Roof, Gutters, Downspouts	\$ 11,000
4 Construction	Electric	\$ 13,000
5 Construction	Plumbing	\$ 11,000
6 Construction	HVAC	\$ 11,000
7 Construction	Masonry	\$ -
8 Construction	Windows	\$ 5,400
9 Construction	Framing	\$ 30,000
10 Construction	Rough Carpentry	\$ 15,000
11 Construction	Drywall	\$ 6,000
12 Construction	Finish Carpentry	\$ 3,000
13 Construction	Insulation	\$ 1,000
14 Construction	Painting	\$ 3,000
15 Construction	Flooring	\$ 4,000
16 Construction	Landscaping	\$ 2,000
17 Construction	Excavation & Basement	\$ 19,000
18 Construction	Appliances (Fridge, Oven/Stove, Laundry)	\$ 5,500
19 Construction	Exterior & Interior Doors	\$ 3,000
20 Construction	Exterior Siding	\$ 3,000
21 Construction	Concrete/Asphalt 2-car parking slab and	\$ 2,500
	Hard Cost Subtotal	\$ 149,900
23 Construction	General Contractor Fees - 10% - Overhead, Profit and General Conditions	\$ 14,990
24 Construction	Hard Cost Contingency - 5%	\$ 8,245
	<b>HARD COSTS TOTAL</b>	<b>\$ 173,135</b>

<b>SOFT COSTS</b>		
1 Soft Cost	Architect Design	\$ 3,500
2 Soft Cost	Architec Admin	\$ 1,500
3 Soft Cost	Lending Fees	\$ 1,000
4 Soft Cost	Legal Fees	\$ 1,000

5 Soft Cost	3rd Party Inspections	\$ 2,000
6 Soft Cost	Title Policy	\$ 500
7 Soft Cost	Insurance	\$ 500
8 Soft Cost	Construction Loan Interest	\$ 3,000
9 Soft Cost	Legal Contracts (Developer Agreement, General Contractor, Architect and Subcontractor)	\$ 1,500
10 Soft Cost	Broker's Sales Fee	\$ 6,000
<b>SOFT COSTS TOTAL</b>		<b>\$ 20,500</b>
<b>TOTAL DEVELOPMENT COST</b>		<b>\$ 193,635</b>

## SAMPLE: Homeownership Affordability Analysis

Homeownership Affordability Analysis		
		Cost per HOME
Total Development Cost (less Developer Fee)		\$193,635
- <i>LESS ARPA Subsidy</i>		<b>\$109,000</b>
Development cost less subsidy		\$84,635
+ <i>ADD Developer Fee earned</i>		\$17,040
<b>Sales Price:</b>		<b>\$101,675</b>
- <i>LESS \$15,000 Downpayment Assistance</i>		<b>\$15,000</b>
Sales price less down payment		\$86,675
Mortgage amount		\$86,675
<b>Monthly Housing Cost:</b>		
<i>Principal &amp; Interest Payments</i>		\$414
<b>Interest Rate (4%)*</b>	4%	
Term Years (30 years)	30	
Private Mortgage Insurance (assumes waived by lender)		
Taxes (assumes \$110,000 assessed value & 2.6% mill rate).		\$238
Property Insurance (assumes \$1,000 /year)		\$83
<b>Total monthly Principal, Interest, Taxes &amp; Insurance (PITI only)</b>		<b>\$735</b>
<i>Monthly Utility Costs</i>		
Heating - Gas		\$52
Water Heating - Gas		\$11
General - Electric		\$41
Cooking - Electric		\$13
Water, Trash, Snow & Ice		\$77
Stove - Electric		\$1
Refrigerator		\$2
Fixed charges - Gas & Electric		\$23
<b>Total monthly Utility Costs</b>		<b>\$220</b>
<b>Total monthly maintenance &amp; repairs</b>		<b>\$100</b>
<b>MONTHLY HOUSING COSTS - GRAND TOTAL</b>		<b>\$1,055</b>

## Affordability Measures

Required <u>monthly income</u> in order to spend 30% of income on <b>PITI only</b>	\$2,452
Required <u>annual income</u> in order to spend 30% of income on <b>PITI only</b>	\$29,419
Required <u>hourly wage</u> in order to spend 30% of income on <b>PITI only</b>	\$14.14
% Affordability of <b>PITI only</b> based upon <u>City of Milwaukee</u> median household income	64.92%
Required monthly income in order to spend 30% of income on ALL HOUSING COSTS	\$3,518
Required annual income in order to spend 30% of income on ALL HOUSING COSTS	\$42,219
Required hourly wage in order to spend 30% of income on ALL HOUSING COSTS	\$20.30
% Affordability of ALL HOUSING COSTS based upon City of Milwaukee median household income	93.16%
City of Milwaukee Median Household Income	\$45,318

City of Milwaukee Utility Allowance 2022

<https://www.hacm.org/home/showpublisheddocument/8883/637920129937800000>

Median household income (in 2021 dollars), 2017 to 2021

<https://www.census.gov/quickfacts/fact/table/milwaukeeecitywisconsin/RHI125221>

**\* CDA and LISC Milwaukee have identified a partner that will provide a 30-year fixed rate permanent loan at 4% interest to eligible homebuyers.**

## **EXHIBIT E - General RFP Requirements**

- 1. Interpretations of the RFP** - Any requests for interpretation of the RFP should be submitted in writing to Teig Whaley-Smith, Chief Alliance Officer, Community Development Alliance, teig@housingplan.org. No oral interpretations will be made to any Respondents as to the meaning of the RFP requirements. All interpretations will be posted and answered on the internet for public consumption. If you downloaded the RFP from the internet, you will be responsible for keeping abreast of the addenda as such addenda are added to the RFP. All such addenda shall become a part of the RFP, and all Respondents shall be bound by such, whether or not received by the Respondents.
- 2. Receipt of Proposals** - Proposals received prior to the time of opening will be secure. The CDA officer designated to open the proposals will decide when the specified time has arrived, and no proposal received thereafter will be considered. No responsibility will be attached to a CDA designated officer for the premature opening of a proposal not properly addressed and identified. The Respondents are cautioned to allow ample time for transmittal of proposals by email.
- 3. Withdrawal of Proposals** – Any Respondent may withdraw a proposal upon written request by such Respondent in time for delivery in the normal course of business prior to the time fixed for closing on the land acquisition with the City. Negligence on the part of the Respondent in preparing a proposal for offer confers no right of withdrawal or modification of the proposal after such proposal has been opened. In case of withdrawal of a proposal by a Respondent, CDA may disqualify such Respondent from submitting a second proposal for the Project.
- 4. Rejection of Proposals** – CDA, and its collaborators, reserve the right to reject the proposal of any Respondent that (i) has previously failed to perform properly or to complete on time contracts of a similar nature, (ii) is not in a position to perform the contract, or (iii) has habitually and without just cause neglected the payment of bills or otherwise disregarded obligations to subcontractors or employees. CDA reserves the right to waive the deficiency and continue the review and scoring of proposals if deemed in the best interest of CDA. Should CDA determine that a Respondent failed to substantially comply with the requirements of the RFP, CDA will notify such Respondent in writing immediately upon determination as to such failure.
- 5. Award of Development Agreements** – A panel assembled by CDA will evaluate proposals. Such panel will evaluate each of the proposals against the evaluation factors set forth in this RFP. Such panel will not make available of any proposal to any Respondent. However, CDA and its collaborators, reserve the right to enter into discussion with the Respondents to seek clarification or to request further information. Following ranking of proposals, the evaluation team may invite the Respondents with the highest rankings to participate in an interview. CDA maintains the right to solicit Best and Final Offer from the Respondents with the highest rankings.
- 6. Notification** -- After the Successful Respondents are selected, all other Respondents will receive a written acknowledgment of the status of their proposals. Neither CDA nor its collaborators, will reimburse the Respondents for any expenses associated with the submission of proposals or participation in the interviews.
- 7. Agreement with LISC** - Enter into an Agreement with LISC for up to \$4.5 million (the “Agreement”). The Agreement will require each of the Successful Respondents to comply with the requirements of ARPA, including 31 C.F.R. Part 35, Subpart A (Coronavirus State and Local Fiscal Recovery Funds) and 2 C.F.R. Part 200 (Uniform Guidance) (the “Uniform Guidance”).
- 8. Land Sale and Cooperation Agreement with the City.** Enter into a Land Sale and Cooperation Agreement with the City and related agencies to facilitate the sale of the land where the Successful Respondents will construct the Project Homes.

9. **Miscellaneous** – CDA and its collaborators reserve the right to waive informalities in any proposals, reject any or all proposals in whole or in part, with or without cause, and to accept those proposals which in the best judgment of CDA and its collaborators meet the needs of the Project. This RFP is for a referral to the appropriate CDA collaborator, and the Respondents may have protest rights under applicable ordinances. While an appeal process is in progress, collaborators may proceed to contract with the Successful Respondents, or may amend existing contracts, even if an appeal is pending if it is in the best interest of the collaborator to do so.
10. **Equal Employment Opportunity** – The Respondents agree that there will not be discrimination as to race, sex, sexual orientation, religion, color, age, creed, or national origin in regard to obligation, work, and services performed under the terms of any contract ensuing from this RFP. The Respondents must agree to comply with Executive Order No. 11246, entitled “Equal Employment Opportunity” and as amended by Executive Order No. 11375, as supplemented by the United States Department of Labor Regulations (41 C.F.R., Part 60).
11. **Indemnification** – Each Respondent agrees to indemnify, save, and hold harmless CDA, LISC, the City, Milwaukee County, and other collaborators for this RFP, their officers, employees, or agents, from and against all claims, demands, actions, damages, loss, costs, liabilities, expenses, judgments, and litigation costs, including reasonable attorney’s fees, photocopying expenses and expert witness fees, recovered from or asserted against CDA, the City, Milwaukee County, or any other collaborators for this RFP, on account of injury or damage to person or property or breach of contract to the extent that such damage, injury, or breach may be incident to, arising out of, or be caused, either directly or proximately, wholly or in part, by an act or omission, negligence, or misconduct on the part of such Respondent or any of its agents, servants, employees, or subcontractors. CDA, LISC, the City, Milwaukee County, and other collaborators for this RFP, shall tender the defense of any claim or action at law or in equity, arising out of or otherwise related to an act or omission, negligence, misconduct, or breach of contract on the part of any Respondent or any of its agents, servants, employees or subcontractors, to such Respondent or its insurer and, upon such tender, it shall be the duty of such Developer and its insurer to defend such claim or action without cost or expense to CDA, the City, Milwaukee County, or any other collaborators for this RFP.
12. **Wisconsin Public Records Law** – The Respondents understand that public collaborators of CDA are bound by the Wisconsin Public Records Law, and as such, all of the terms of this RFP are subject to and conditioned on the provisions of Wis. Stat. 19.21, et seq. Each Respondent acknowledges that it is obligated to assist public collaborators in retaining and producing records that are subject to Wisconsin Public Records Law, and that the failure to do so shall prevent such Respondent from becoming a Successful Respondent, and that such Respondent must defend and hold public collaborators harmless from liability under that law. Except as otherwise authorized, those records shall be maintained for a period of seven years after the date of this RFP.



## EXHIBIT F - Terms Required for the Use of Federal Funds

In the event of a conflict between this Exhibit F (“Federally Required Contract Terms”) and the terms of the main body of the Contract or any exhibit or appendix, these Federally Required Contract Terms shall govern.

1. **Debarment and Suspension.** Contractor represents and warrants that, as of the execution of this Contract, neither Contractor nor any subcontractor or sub-consultant performing work under this Contract (at any tier) is included on the federally debarred bidder’s list listed on the government-wide exclusions in the System for Award Management (SAM), in accordance with the OMB guidelines at 2 CFR 180 that implement Executive Orders 12549 (3 CFR part 1986 Comp., p. 189) and 12689 (3 CFR part 1989 Comp., p. 235), “Debarment and Suspension.” If at any point during Contract’s term Contractor or any subcontractor or sub-consultant performing work at any tier is included on the federally debarred bidder’s list, Contractor shall notify City immediately. Contractor’s completed Vendor Debarment Certification is attached hereto and incorporated herein.
2. **Amendment Permitted.** This list of Federally Required Contract terms may be amended by City in the event that the applicable federal grant providing funding for this Agreement contains additional required terms.
3. **Record Retention.** Contractor certifies that it will comply with the record retention requirements detailed in 2 CFR § 200.333. Contractor further certifies that it will retain all records as required by 2 CFR § 200.333 for a period of three (3) years after it receives City notice that City has submitted final expenditure reports or quarterly or annual financial reports, as applicable, and all other pending matters are closed. Unless Contractor is functioning as a sub-recipient of grant funding, rather than as a contractor, this requirement is in addition to, and not in place of, City’s public records retention requirements set forth elsewhere herein.
4. **Procurement of Recovered Materials.** Pursuant to 2 CFR §200.323, Contractor represents and warrants that in its performance under the Contract, Contractor shall comply with section 6002 of the Solid Waste Disposal Act, as amended by the Resource Conservation and Recovery Act. The requirements of Section 6002 include procuring only items designated in guidelines of the Environmental Protection Agency (EPA) at 40 CFR Part 247 that contain the highest percentage of recovered materials practicable, consistent with maintaining a satisfactory level of competition, where the purchase price of the item exceeds \$10,000 or the value of the quantity acquired during the preceding fiscal year exceeded \$10,000; procuring solid waste management services in a manner that maximizes energy and resource recovery; and establishing an affirmative procurement program for procurement of recovered materials identified in the EPA guidelines.
5. **Clean Air Act (42 U.S.C. 7401-7671q.) and the Federal Water Pollution Control Act (33 U.S.C. 1251-1387), as amended**—If this is a contract or sub-grant in excess of \$150,000, Contractor must comply with all applicable standards, orders or regulations issued pursuant to the Clean Air Act (42 U.S.C. 7401-7671q) and the Federal Water Pollution Control Act as amended (33 U.S.C. 1251-1387). Violations must be reported to the Federal awarding agency and the Regional Office of the Environmental Protection Agency (EPA).
6. **Energy Efficiency.** Contractor certifies that Contractor will be in compliance with mandatory standards and policies relating to energy efficiency, which are contained in the state energy conservation plan issued in compliance with the Energy Policy and Conservation Act (Pub. L. 94- 163, 89 Stat. 871).
7. **Byrd Anti-Lobbying Amendment** (31 U.S.C. 1352). Contractor certifies that:

7.1. No federal appropriated funds have been paid or will be paid, by or on behalf of Contractor, to any person for influencing or attempting to influence an officer or employee of an agency, a Member of Congress, an officer or employee of Congress, or an employee of a Member of Congress in connection with the awarding of any Federal contract, the making of any Federal grant, the making of any Federal Loan, the entering into of any cooperative agreement, and the extension, continuation, renewal, amendment, or modification of and Federal contract, grant, loan, or cooperative agreement.

7.2. If any funds other than federal appropriated funds have been paid or will be paid to any person for making lobbying contacts to an officer or employee of an agency, a Member of Congress, an officer or employee of Congress, or an employee of a Member of Congress in connection with this federal contract, grant, loan, or cooperative agreement, Contractor shall request from City and provide, completed, to City the "Disclosure Form to Report Lobbying," in accordance with its instructions as amended by "Government wide Guidance for New Restrictions on Lobbying," 61 Fed. Reg. 1413 (1/19/96).

7.3. Contractor shall require that the language of this certification be included in the award documents for all sub-awards at all tiers (including subcontracts, sub-grants, and contracts under grants, loans, and cooperative agreements) and that all sub-recipients shall certify and disclose accordingly.

7.4. Contractor's completed Byrd Anti-Lobbying Certification is attached hereto and incorporated herein.

8. **Contract Work Hours and Safety Standards Act (40 U.S.C. 3701-3708).** If this Contract is for an amount in excess of \$100,000 and involves the employment of mechanics or laborers, Contractor must comply with 40 U.S.C. 3702 and 3704, as supplemented by Department of Labor regulations (29 CFR Part 5). Under 40 U.S.C. 3702 of the Act, Contractor must compute the wages of every mechanic and laborer on the basis of a standard work week of 40 hours. Work in excess of the standard work week is permissible provided that the worker is compensated at a rate of not less than one and a half times the basic rate of pay for all hours worked in excess of 40 hours in the work week. The requirements of 40 U.S.C. 3704 are applicable to construction work and provide that no laborer or mechanic must be required to work in surroundings or under working conditions which are unsanitary, hazardous or dangerous. These requirements do not apply to the purchases of supplies or materials or articles ordinarily available on the open market, or contracts for transportation or transmission of intelligence.
9. **Right to Inventions.** If the federal award is a "funding agreement" under 37 CFR 401.2 and this is an agreement between City or a sub-recipient and a small business firm or nonprofit organization regarding the substitution of parties, assignment of performance or experimental, developmental or research work thereunder, City or sub-recipient will comply with 37 CFR Part 401, "Rights to Inventions Made by Nonprofit Organizations and Small Business Firms Under Government Grants, Contracts and Cooperative Agreements," and any implementing regulations issued by the awarding agency.
10. **DHS Seal, Logo, and Flags.** Contractor shall not use the Department of Homeland Security ("DHS") seal(s), logos, crests, or reproductions of flags or likenesses of DHS agency officials without specific FEMA pre-approval.
11. **Federal Government is Not a Party.** The Federal Government is not a party to this Contract and is not subject to any obligations or liabilities to City, Contractor, or any other party pertaining to any matter resulting from the Contract.
12. **Copeland "Anti-Kickback" Act (40 U.S.C. 3145).** If this is a "prime construction contract" in excess of

\$2,000, Contractor shall, in its performance of the contract, comply with the Copeland "Anti-Kickback" Act (40 U.S.C. 3145), as supplemented by Department of Labor regulations (29 CFR Part 3, "Contractors and Subcontractors on Public Building or Public Work Financed in Whole or in Part by Loans or Grants from the United States"). The Act provides that Contractor is prohibited from inducing, by any means, any person employed in the construction, completion, or repair of public work, to give up any part of the compensation to which he or she is otherwise entitled.

13. **Equal Employment Opportunity.** If this is a "federally assisted construction contract," as defined by 41 CFP Part 60- 1.3, except as otherwise provided in 41 CFR Part 60, in its performance under the contract, the 41 CFP Part 60-1.3 shall comply with the equal opportunity clause provided under 41 CFR 60-1.4(b), in accordance with Executive Order 11246, "Equal Employment Opportunity" (30 FR 12319, 12935, 3 CFR Part, 1964-1965 Comp., p. 339), as amended by Executive Order 11375, "Amending Executive Order 11246 Relating to Equal Employment Opportunity," and implementing regulations at 41 CFR part 60, "Office of Federal Contract Compliance Programs, Equal Employment Opportunity, Department of Labor." The text of 41 CFR 60-1.4(b) is available upon request.
14. **Termination for convenience.** If this Contract is for an amount in excess of \$10,000 and it lacks a termination for convenience clause, the following applies: City may terminate this Contract at any time for any reason by giving at least thirty (30) days' notice in writing from City to Contractor. If Contractor is terminated for convenience by City, Contractor will be paid for services actually performed or commodity actually provided.
15. **Termination for cause.** If this Contract is for an amount in excess of \$10,000 and it lacks a termination for cause clause, the following applies: If Contractor shall fail to fulfill in timely and proper manner any of its obligations or violate any of the provisions of this Contract; City shall have the right to terminate this Contract. City shall notify Contractor of its intent to terminate, by giving Contractor prior written notice at least five (5) business days before the effective date of the termination, identifying the alleged deficiencies in Contractor's performance, and shall give Contractor thirty (30) days to cure such deficiencies prior to termination. In such event, all deliverables completed by Contractor as of the date of termination shall, at the option of City, become property of City. Notwithstanding the above, Contractor shall not be relieved of liability to City for damages sustained by City by virtue of any breach of the Contract, and City shall retain its remedies under law.
16. **Executive Order 13202- Preservation of Open Competition and Government Neutrality Towards Contractors' Labor Relations on Federal and Federally Funded Construction Contracts.** These requirements apply to recipients and sub-recipients of awards and cooperative agreements and to any manager of a construction project acting on their behalf. These individuals or employees of one of these organizations must ensure that the bid specifications, project agreements, and other controlling documents do not: (a) require or prohibit bidders, offerors, contractors, or subcontractors to enter into or adhere to agreements with one or more labor organizations, on the same or other related construction project(s); or (b) otherwise discriminate against bidders, offerors, contractors, or subcontractors for becoming or refusing to become or remain signatories, or otherwise to adhere to agreements with one or more labor organizations,

on the same or other related construction project(s). Contractors or subcontractors are not prohibited from voluntarily entering into agreements with one or more labor organizations.

17. **Domestic preferences for procurements.** Pursuant to 2 CFR §200.322, as appropriate, and to the extent consistent with law, Contractor should, to the greatest extent practicable under this Contract, provide a preference for the purchase, acquisition, or use of goods, products, or materials produced in the United States (including but not limited to iron, aluminum, steel, cement, and other manufactured products). The requirements of this section must be included in all subcontracts and purchase orders for work or products under this Contract.
18. **Prohibition on Certain Telecommunications and Video Surveillance Services or Equipment.** Contractor shall not use funds under this Contract to purchase, or enter into subcontracts to purchase, any equipment, services, or systems that use telecommunications equipment or services as a substantial or essential component of a system that is subject to [2 CFR § 200.216](#) (generally, video surveillance or telecommunications equipment produced by Huawei Technologies Company, ZTE Corporation, Hytera Communications Corporation, Hangzhou Hikvision Digital Technology Company, or Dahua Technology Company, their subsidiaries or affiliates, or any entity that the Secretary of Defense reasonably believes to be an entity owned or controlled by the government of a foreign country). In the event Contractor identifies covered telecommunications equipment or services that constitute a substantial or essential component of any system, or as critical technology as part of any system that is subject to 2 CFR § 200.216, during Contract performance, Contractor shall alert City as soon as possible and shall provide information on any measures taken to prevent recurrence.
19. **Treasury Regulations.** This Contract is subject to 2 C.F.R. Part 180 and Treasury's implementing regulation at 31 C.F.R. Part 19.
20. **SAM.gov.** Universal Identifier and System for Award Management (SAM), 2 C.F.R. Part 25, pursuant to which the award term set forth in Appendix A to 2 C.F.R. Part 25 is hereby incorporated by reference.
21. **Drug Free Workplace.** Governmentwide Requirements for Drug-Free Workplace, 31 C.F.R. Part 20 are hereby incorporated by reference and bind Contractor.
22. **New Restrictions on Lobbying.** New Restrictions on Lobbying, 31 C.F.R. Part 21 are hereby incorporated by reference and bind Contractor.
23. **Uniform Relocation Assistance and Real Property Acquisitions Act of 1970.** Uniform Relocation Assistance and Real Property Acquisitions Act of 1970 (42 U.S.C. §§ 4601-4655) and implementing regulations are hereby incorporated by reference and bind Contractor.
24. **Federal environmental laws.** Generally applicable federal environmental laws and regulations are hereby incorporated by reference and bind Contractor.

25. **Federal antidiscrimination laws statutes.** Additionally, the federal statutes and regulations prohibiting discrimination are applicable to this Contract and bind Contractor, include, without limitation, the following:

25.1. Title VI of the Civil Rights Act of 1964 (42 U.S.C. §§ 2000d et seq.) and Treasury's implementing regulations at 31. Additionally, by signing this Contract or Amendment, as applicable, Contractor certifies that:

*The contractor or subcontractor shall comply with Title VI of the Civil Rights Act of 1964, which prohibits recipients of federal financial assistance from excluding from a program or activity, denying benefits of, or otherwise discriminating against a person on the basis of race, color, or national origin (42 U.S.C. § 2000d et seq.), as implemented by the Department of the Treasury's Title VI regulations, 31 C.F.R. Part 22, which are herein incorporated by reference and made a part of this contract (or agreement). Title VI also includes protection to persons with "Limited English Proficiency" in any program or activity receiving federal financial assistance, 42 U.S.C. § 2000d et seq., as implemented by the Department of the Treasury's Title VI regulations, 31 C.F.R. Part 22, and herein incorporated by reference and made a part of this contract or agreement.*

25.2. 26.2. C.F.R. Part 22, which prohibit discrimination on the basis of race, color, or national origin under programs or activities receiving federal financial assistance;

25.3. 26.3. The Fair Housing Act, Title VIII of the Civil Rights Act of 1968 (42 U.S.C. §§ 3601 et seq.), which prohibits discrimination in housing on the basis of race, color, religion, national origin, sex, familial status, or disability;

25.4. Section 504 of the Rehabilitation Act of 1973, as amended (29 U.S.C. § 794), which prohibits discrimination on the basis of disability under any program or activity receiving federal financial assistance;

25.5. The Age Discrimination Act of 1975, as amended (42 U.S.C. §§ 6101 et seq.), and Treasury's implementing regulations at 31 C.F.R. Part 23, which prohibit discrimination on the basis of age in programs or activities receiving federal financial assistance; and

25.6. Title II of the Americans with Disabilities Act of 1990, as amended (42 U.S.C. §§ 12101 et seq.), which prohibits discrimination on the basis of disability under programs, activities, and services provided or made available by state and local governments or instrumentalities or agencies thereto.

**27. Increasing Seat Belt Use in the United States.** Pursuant to Executive Order 13043, 62 FR 19217 (Apr. 18, 1997), Contractor is encouraged to adopt and enforce on-the-job seat belt policies and programs for its employees when operating company-owned, rented or personally owned vehicles.

**28. Reducing Text Messaging While Driving.** Pursuant to Executive Order 13513, 74 FR 51225 (Oct. 6, 2009), Contractor is encouraged to adopt and enforce policies that ban text messaging while driving, and should establish workplace safety policies to decrease accidents caused by distracted drivers.